

KEITHLEY

MODEL 617
PROGRAMMABLE ELECTROMETER

QUICK REFERENCE GUIDE

INTRODUCTION

This reference and programming guide contains condensed specifications, descriptions of the various features and information for using the Model 617.

Included with descriptions of each feature are brief operating instructions and some examples of typical uses.

Included with the programming information are several example programs utilizing some commonly used controllers to get the Model 617 "up and running" on the IEEE-488 bus.

© 1984, Keithley Instruments, Inc.
Cleveland, Ohio, U.S.A.
Document Number 617-903-01 Rev. A

CONTENTS

CONDENSED SPECIFICATIONS	3
MODEL 617 FEATURES	7
IEEE-488 PROGRAMMING	35
PROGRAMS	41
DATA STORE OPERATION	42
USING HP-85	
IBM PC or XT Personal Computer	43
(Using Keithley Model 8573 Interface)	
APPLE II (Using Apple Interface)	45
HP-85	46
HP-9825A	47
HP-9816	48
DEC LSI 11	49
PET/CBM 2001	51

CONDENSED SPECIFICATIONS

VOLTS		
Range	Resolution	Accuracy 1 year, 18–28°C ± (%rdg + counts)
200mV	10 μ V	0.05% + 4
2 V	100 μ V	0.05% + 1
20 V	1mV	0.05% + 1
200 V	10mV	0.07% + 1

INPUT IMPEDANCE: > 200T Ω in parallel with 20pF (< 2pF guarded).

AMPS		
Range	Resolution	Accuracy 1 year, 18–28°C ± (%rdg + counts)
2 pA	0.1fA	1.6 % + 66
20 pA	1 fA	1.6 % + 7
200 pA	10 fA	1.6 % + 1
2 nA	100fA	0.25% + 5
20 nA	1 pA	0.25% + 1
200 nA	10 pA	0.25% + 1
2 μ A	100pA	0.15% + 4
20 μ A	1 nA	0.15% + 1
200 μ A	10 nA	0.15% + 1
2mA	100nA	0.15% + 4
20mA	1 μ A	0.15% + 1

INPUT VOLTAGE BURDEN: < 1mV except 3mV on 20mA range.

OHMS			
Range	Resolution	Accuracy 1 year, 18–28°C ± (%rdg + counts)	Test Current ± 1.5%
2 kΩ	0.1 Ω	0.2 % + 4	100μA
20 kΩ	1 Ω	0.15% + 1	100μA
200 kΩ	10 Ω	0.25% + 1	10μA
2MΩ	100 Ω	0.25% + 1	1μA
20MΩ	1 kΩ	0.25% + 1	100nA
200MΩ	10 kΩ	0.3 % + 1	10nA
2GΩ	100 kΩ	1.5 % + 1	1nA
20GΩ	1MΩ	1.5 % + 1	1nA
200GΩ	10MΩ	1.5 % + 1	1nA

MAXIMUM OPEN CIRCUIT VOLTAGE: 300VDC.

COULOMBS		
Range	Resolution	Accuracy 1 year, 18–28°C ± (%rdg + counts)
200pC	10fC	0.4% + 4
2nC	100fC	0.4% + 1
20nC	1pC	0.4% + 1

VOLTAGE SOURCE

OUTPUT: –102V to +102V in 50mV steps.

ACCURACY: 1 year, 18–28°C; ±(0.2% + 50mV)

MAXIMUM OUTPUT CURRENT: ±2mA, active current limit at <4mA with annunciation.

GENERAL

CONVERSION TIME: 330msec.

MAXIMUM INPUT: 250V peak, DC to 60Hz sinewave, 10sec per minute max on mA ranges.

ELECTROMETER MAX COMMON-MODE VOLTAGE: 500V peak.

V-SOURCE MAX COMMON-MODE VOLTAGE: 100V peak.

ENVIRONMENT:

Operating: 0°C to 50°C. 70% relative humidity up to 35°C.

Storage: -25°C to +65°C.

WARMUP: 1 hour to rated accuracy.

ENGINEERING UNITS CONVERSION

SYMBOL	PREFIX	EXPONENT
f	femto-	10^{-15}
p	pico-	10^{-12}
n	nano-	10^{-9}
u	micro-	10^{-6}
m	milli-	10^{-3}
k	kilo-	10^3
M	mega-	10^6
G	giga-	10^9
T	tera-	10^{12}
P	peta-	10^{15}

SAFETY PRECAUTIONS

1. Before operation, ground the instrument through a properly earth grounded power receptacle.
2. Before servicing, disconnect the instrument from the power line, all other equipment and consult the Model 617 Instruction Manual.
3. Do not touch any terminals while the instrument is turned on or connected to any other test equipment.

DISPLAY ANNUNCIATORS

Readings can be displayed with either alpha exponents or numeric exponents. A front panel program toggles the exponent mode (see PROGRAM FEATURES).

ALPHA EXPONENTS

mV or V: millivolts or volts.

k Ω , M Ω , G Ω , T Ω or P Ω : kilohms, megohms, gigohms, teraohms or petaohms.

pA, nA, μ A or mA: picoamps, nanoamps, microamps or milliamps.

nC or pC: nanocoulombs or picocoulombs.

NUMERIC EXPONENTS

Positive Exponents: 0 through 18.

Negative Exponents: -01 through -12.

Example: A displayed exponent of -12 = 10^{-12} .

Display Status—Three indicator lights define what is being read on the display.

METER Indicator Light—Indicates that electrometer readings are being displayed.

SOURCE Indicator Light—Indicates that the voltage source (V-SOURCE) value is being displayed.

DATA Indicator Light—Indicates that the data store is in the recall mode and a previously stored reading is being displayed. A flashing DATA light indicates that the data store is full.

NOTE:

The DISPLAY button toggles the display between source and the current mode (METER or DATA).

IEEE Status Indicators—The TALK, LISTEN and REMOTE indicators are used when programming the instrument over the IEEE-488 bus. These status lights are not operational during front panel instrument operation.

DISPLAY MESSAGES

The following messages will be displayed to flag errors or conditions as they occur:

MESSAGE	DESCRIPTION
OL	Overrange input applied.
r.r.	Displayed briefly on power up; RAM test passed. Displayed constantly; RAM test failed.
n Err	Number Error. Calibration or voltage source value exceeds limits.
b Err	Bus Error. Instrument programmed while not in remote or an illegal command (IDDC) sent or an illegal command option (IDDCO) sent.
t Err	Trigger Overrun Error. Instrument triggered while processing reading from previous trigger.
. .	Flashing decimal points on exponent LEDs; not using stored cal constants. Constant decimal points; instrument in calibration mode
IEEE "address"	Program message; in IEEE address program.
diSP	Program message; in display mode program.
CAL	Program message; in cal constant program.
Blinking AMPS light	In V/I current overload.
Blinking ZERO CHECK light	In V/I zero check.

SHIFT FEATURE

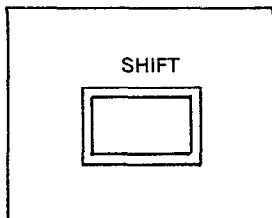

DESCRIPTION

Several of the front panel buttons have a secondary function. These functions are labeled on the front panel in the same color as the shift button. A secondary function is selected by first pressing the *SHIFT* button and then pressing the appropriate button. More information on these secondary functions can be found in the following text.

ZERO CHECK and ZERO CORRECT

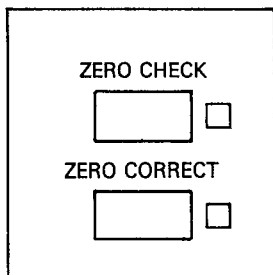

DESCRIPTION

The zero check feature provides a means for internal zero verification. The zero correct feature, when used with zero check, corrects internal offsets in the instrument so that the display reads zero. In the zero check mode, the input impedance of the Model 617 is changed as outlined in the following table.

INPUT IMPEDANCE WITH ZERO CHECK ENABLED

FUNCTION	RANGE	IMPEDANCE IN ZERO CHECK
Volts	All	10M Ω 20pF
Resistance	All k Ω , 2M Ω 20M Ω , 200M Ω , All G Ω	909k Ω 1120pF 9.09M Ω 47pF
Coulombs	All	10M Ω 1020pF
Current	All pA All nA All μ A All mA	10M Ω 25pF 9.09M Ω 47pF 99k Ω 1020pF 100 Ω 20pF

OPERATION

Zero Verification and Correction

1. Allow the instrument to warm up for one hour after power up.
2. Turn zero check on by pressing the ZERO CHECK button. The ZERO CHECK indicator light will turn on.
3. Select the function and range that will be used. If unsure of range, select the lowest range.
4. If the display does not read zero, press the ZERO CORRECT button. The ZERO CORRECT indicator light will turn on and the display will read zero.
5. Take the instrument out of zero check by again pressing the ZERO CHECK button. The ZERO CHECK indicator light will turn off.
6. The instrument is now zeroed and ready to make measurements.

NOTES

1. The instrument can be rezeroed at any time by turning zero correct off (ZERO CORRECT indicator light off) and repeating steps 1 through 5.
2. Correction is automatically scaled when range is changed. However, it is recommended that zero be checked after range or function is changed. If range or function is to be changed without rezeroing, initially zero correct on the lowest range of the function to be used.
3. Check zero every 24 hours, or whenever there is a $> 1^{\circ}\text{C}$ temperature change.
4. On power up, zero check is on.

TYPICAL USE

Zero the 2pA range to ensure accurate measurements on that range.

MEASUREMENT MODES

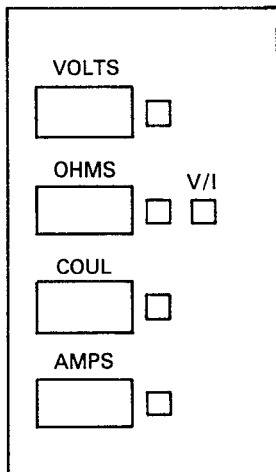

DESCRIPTION

These buttons place the Model 617 in the desired electrometer measurement mode. The VOLTS and OHMS buttons have secondary functions: external feedback and V/I modes respectively. In the external feedback mode, the internal feedback elements are electrically removed from the circuit so that an external element can be used instead. The V/I mode utilizes the V-Source to extend the resistance measurement capabilities of the Model 617 to $10^{16}\Omega$. In this mode the Model 617 automatically calculates the resistance from the programmed voltage value and measured current, and then displays it.

OPERATION

Volts, Ohms and Amps:

1. Turn zero check on.
2. Determine the signal to be measured.

3. Press the appropriate function button.
4. Select an appropriate range or autorange.
5. Zero correct the instrument if it is not reading zero.
6. Apply the signal to the triax input connector on the rear panel.
7. Turn zero check off.

Coulombs:

1. Turn zero check on.
2. Press the COUL button.
3. Select an appropriate range or autorange.
4. Zero correct the instrument if it is not reading zero.
5. Turn zero check off.
6. Turn suppress on to cancel the small amount of charge error introduced by turning zero check off.
7. Apply the signal to the triax input connector on the rear panel.

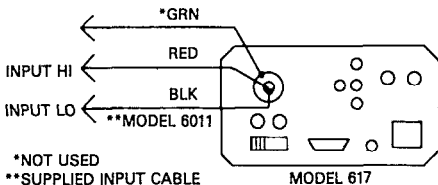
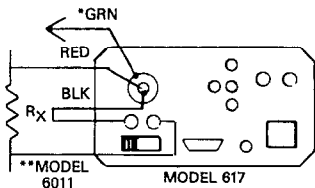

Fig 1. Voltage Resistance, Current and Charge Measurements

V/I:

1. Turn zero check on.
2. Select the current function and an appropriate range (autorange suggested).
3. Zero correct the instrument if it is not reading zero.
4. Set the voltage source (V-Source) to an appropriate level. (See page 20 for V-Source operation).
5. Connect the resistance to be measured to the Model 617 as shown.
6. Press the V-Source OPERATE button (OPERATE light on).
7. Turn zero check off.

8. Note the current reading on the display. If this current is to be suppressed, press the SUPPRESS button (SUPPRESS light on).
9. Select the V/I function by pressing the SHIFT button and then the OHMS button. The V/I indicator light will turn on.
10. If the displayed resistance measurement is to be suppressed, press the SUPPRESS button. Otherwise, take the resistance measurements, in ohms, from the display.



*NOT USED

**SUPPLIED INPUT CABLE

$$R_X = \frac{\text{SOURCE VOLTAGE}}{\text{MEASURED CURRENT}}$$

Fig 2. V/I Measurements

NOTES

1. To exit the V/I mode, press any function button.
2. Suppress can be used with V/I ohms in two different ways. If suppress is enabled with the instrument in the V/I ohms mode, the displayed resistance value (not the current being measured) will be suppressed. In this case, the instrument can be toggled between amps and V/I ohms without cancelling the suppressed resistance value. However, suppress will be temporarily ignored by switching to amps, but it will be reinstated by returning to V/I ohms.

The current can be suppressed by placing the Model 617 in the amps mode and then enabling suppress. Entering the V/I ohms mode after suppress is enabled will not cancel the suppressed current, and the displayed resistance value will reflect the suppressed current (not a suppressed resistance). Again, the instrument can be toggled between V/I ohms and amps without cancelling suppress, but the suppressed value will be a current for both amps and V/I ohms under these conditions.

RANGE

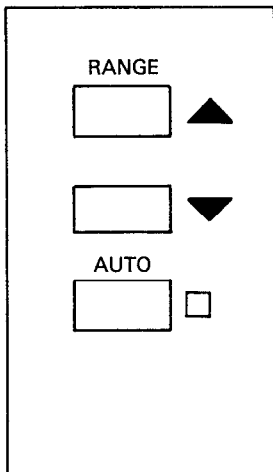

DESCRIPTION

The range buttons select the desired range of measurement for the Model 617. The range may be selected manually or automatically. With manual range selection always use the range that allows the greatest amount of resolution.

OPERATION

AUTO

The AUTO button toggles autoranging and manual ranging. The instrument is in autoranging when the AUTO indicator light is on. If the light is off, press the AUTO button once to get into the autorange mode.

MANUAL

The instrument is in manual range when the AUTO indicator light is off. If the light is on, press the AUTO button once to get into the manual ranging mode. To uprange, press the button showing the arrowhead pointing up. To downrange press the button showing the arrowhead pointing down.

SUPPRESS

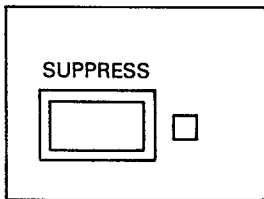

DESCRIPTION

The suppress feature serves as a means of baseline suppression allowing a stored offset value to be subtracted from subsequent readings. When the SUPPRESS button is pressed, the instrument triggers a conversion and stores the reading as a baseline value. All subsequent readings represent the differences between the applied signal level and the stored baseline. The stored baseline can be as small as the resolution of the instrument will allow or as large as full range.

A suppress level can be established for any measurement function and is effective only on that function. Changing functions, except between amps and V/I (see V/I operation), will cancel the suppress level already established. Once a suppress level is established for a measurement function, that stored level will be scaled according to what range the Model 617 is on.

It is important to note that the suppress mode reduces the dynamic range of measurement by that stored level. For example, assume that the suppress level is $+1\mu\text{A}$ and the $2\mu\text{A}$ range is selected. The maximum positive displayed reading, before overranging, would be $+0.9999\mu\text{A}$. This is because the A/D converter would be seeing $1.9999\mu\text{A}$ (maximum) from the input. The dynamic range of measurement is $-1.9999\mu\text{A}$ to $+0.9999\mu\text{A}$ ($2.9998\mu\text{A}$) as compared to the normal $-1.9999\mu\text{A}$ to $+1.9999\mu\text{A}$ ($3.9998\mu\text{A}$) span. The dynamic range of measurement has been reduced by $1\mu\text{A}$ (10,000 counts). The effects of dynamic range can be reduced by selecting a higher range or using autorange.

OPERATION

1. Select function and range.
2. Input the offset or baseline level to the Model 617.
3. Press the SUPPRESS button. The SUPPRESS indicator light will turn on and the display will zero.
4. The stored level will be algebraically subtracted from all subsequent measurements.

NOTE: Suppress can be turned off by again pressing the SUPPRESS button.

TYPICAL USE

1. Cancel external source offset (i.e. calibrator offset).
2. Null out lead resistance on ohms.
3. Null out circuit outputs to display only drift or changes.

TRIG (TRIGGER)

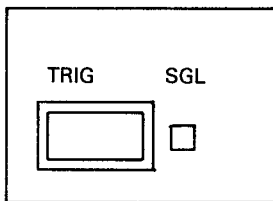

DESCRIPTION

As a bench instrument, the Model 617 has two trigger modes; continuous and single. In the continuous mode, the instrument constantly triggers three readings per second. In the single mode, one reading is triggered every time the TRIG button is pressed or an external trigger is received. When the SGL light is off, the Model 617 is in the continuous trigger mode. When the light is on, the instrument is in the single trigger mode.

OPERATION

Changing From Continuous To Single Trigger:

1. Press the SHIFT button and then the TRIG button. The SGL indicator light will turn on.
2. To trigger a reading, press the TRIG button once. The display will blank momentarily to indicate that one reading was triggered.

Changing From Single To Continuous Trigger:

1. Press the SHIFT button and then the TRIG button. The SGL indicator light will turn off.
2. Readings are now triggering continuously.

TYPICAL USE

The front panel TRIG button can be used to prompt another instrument to perform a specific function, such as outputting a current or voltage level, or changing channels on a scanner. To use in this configuration, the METER COMPLETE OUTPUT of the Model 617 must be connected to the external trigger input of the other instrument.

V-SOURCE

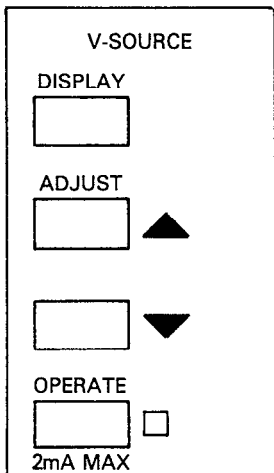

DESCRIPTION

This feature delivers -102.35V to $+102.40\text{V}$ at a maximum of $\pm 2\text{mA}$ to the V-SOURCE OUTPUT binding posts on the rear panel of the Model 617.

OPERATION

WARNING

Hazardous voltages may be present at the output. Make sure that the OPERATE indicator light is off before connecting the V-SOURCE OUTPUT to a load.

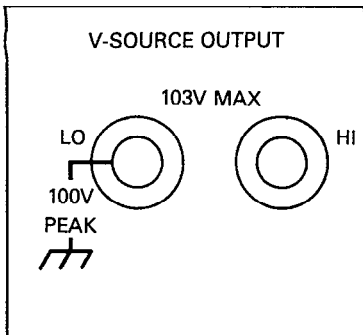

1. Connect a suitable load to the V-SOURCE OUTPUT connectors.
2. Press the DISPLAY button and verify that the SOURCE indicator light is on. This button toggles the meter and source display modes.

NOTE

If the DATA indicator light is on (not blinking), the DISPLAY button will toggle the display between source and data display modes.

3. Using the two ADJUST buttons, set the displayed value to read the desired voltage level. The reading adjust rate will increase if an ADJUST button is held in. For an even faster adjust rate, press the SHIFT button and then hold in an ADJUST button.
4. Press the OPERATE button to output the displayed voltage to the load. The OPERATE indicator light will turn on.
5. To turn off the V-Source function, press the OPERATE button again. The OPERATE light will turn off and the output will be held at $0V \pm 50mV$.

NOTES

1. Current limit will occur at less than 4mA and will cause the OPERATE indicator light to flash.
2. On power up, V-Source will be set to 00.00V.

TYPICAL USE

1. The V-Source is used with the V/I function to extend the resistance measurement capabilities of the Model 617 to $10^{16}\Omega$.
2. The V-Source can also be used to deliver test voltages to external circuits.

DATA STORE with MIN/MAX

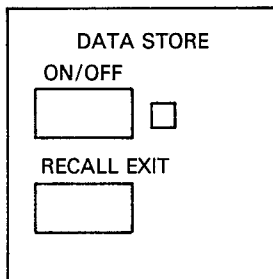

DESCRIPTION

The data store feature saves up to 100 points of data and holds the lowest (Min) and highest (Max) readings while data store is on. The 100 points of data are stored at the rate of one of six selectable rates from every reading (3 per second) to one reading per hour. Also, manual data entry is available (R6). In the continuous trigger mode (SGL light off), the minimum/maximum readings are continuously updated at the rate of three readings per second (regardless of the selected rate) while data store is on.

100 POINT DATA STORAGE

1. Press and hold in the Data Store ON/OFF button. The following storage rates will scroll on the display:
 - r=0 (every reading)
 - r=1 (1 reading per second)
 - r=2 (1 reading per 10 seconds)
 - r=3 (1 reading per minute)
 - r=4 (1 reading per 10 minutes)
 - r=5 (1 reading per hour)
 - r=6 (every time TRIG button is pressed)
2. When the desired storage rate is displayed, release the Data Store ON/OFF button.

NOTE: If you are not ready to store data, turn the data store off. When ready, press and release the Data Store ON/OFF button. The preselected storage rate will be displayed briefly, the indicator light will turn on and the store cycle will start.

3. **Recalling Data**—Data can be recalled at any time, but the flashing DATA indicator light signals that the buffer is full (100 points stored).
 - A. Press and hold in the RECALL button. The DATA indicator light will turn on and the display will scroll through the data and minimum/maximum points. The first data point displayed is the last data point that was stored. The next two points are the maximum (HI) and minimum (LO) readings made during that store cycle.
 - B. Release the RECALL button at the desired data point and note the reading on the display. The data pointer can be incremented by steps of one by momentarily holding in the RECALL button.
 - C. Exit from the recall mode by pressing the SHIFT button and then the RECALL EXIT button. The DATA indicator light will turn off.
4. Turn off the data store cycle by pressing the ON/OFF button. The indicator light will turn off. All stored data is retained until a new store cycle is started, power to the instrument is turned off, or a DCL or SDC is received over the IEEE bus.

TYPICAL USE

1. Saving data points of current drift of a low leakage device such as a FET.
2. Monitoring and saving levels that fluctuate over a period of time.

MIN/MAX

1. Press and release the Data Store ON/OFF button. The indicator light will turn on. In the continuous trigger mode, minimum and maximum readings will continue to update at the rate of three readings per second for as long as the data store is on and storing readings.
2. To recall the minimum/maximum readings:
 - A. Press and hold in the RECALL button. The DATA indicator light will turn on.
 - B. Release the RECALL button when HI is displayed and note the maximum reading.

- C. Again press the **RECALL** button and release it when **LO** is displayed. Note the minimum reading.
 - D. Exit from the recall mode by pressing the **SHIFT** button and then the **RECALL EXIT** button. The **DATA** indicator light will turn off.
3. Turn off the data store cycle by pressing the **ON/OFF** button. The indicator light will turn off. The minimum/maximum readings, along with the other data, will be retained until a new store cycle is started.

NOTE

There must be at least one reading in data store in order to recall the minimum/maximum values.

TYPICAL USE

Detect surges, dips and peak drifts over a period of time.

PROGRAM FEATURES

The Model 617 has front panel programs to:

1. Display and change the IEEE-488 address of the instrument or select the talk only mode.
2. Toggle the display for either alpha exponents or numeric exponents.

The program mode is selected by pressing the SELECT button. Program parameters are changed with the use of the V-Source ADJUST buttons (V-Source is disabled during program select). The adjust buttons increment and decrement the displayed value.

Program Storage and Exit

Exit the program mode and store the parameters by pressing the SHIFT and SELECT EXIT buttons. The instrument will return to the previous mode.

IEEE ADDRESS AND TALK ONLY

To display and change the IEEE address:

1. Press and release the SELECT button until IEEE and the present address number are displayed.
2. To change the address, adjust the display to read the desired primary address (0-30) using the ADJUST buttons.
3. Press the SELECT button to store the new address and exit the program mode.

To select the talk only mode:

1. Press and release the SELECT button until IEEE is displayed.
2. Using the adjust buttons, adjust the display to read 40 for talk only mode with prefix or to 41 for talk only mode without prefix.
3. Press the SELECT button to store the talk only mode and exit the program mode.

NOTE

For more information on talk only operation, see page 40 of this booklet.

DISPLAY EXPONENTS

Do the following to toggle the display for alpha exponents (i.e. μA , $\text{k}\Omega$) or numeric exponents (i.e. -06 , 03).

1. Press and release the SELECT button until DISP is displayed.
2. Press and release either of the ADJUST buttons. The exponent mode will toggle.
3. Press the SELECT button to store the displayed exponent mode and exit the program mode.

2V ANALOG OUTPUT

DESCRIPTION

A voltage level that is proportional to the incoming input level can be monitored using the 2V ANALOG OUTPUT and COM binding posts on the rear panel. All ranges will output 2V at full range. The output is inverted when in volts and ohms.

TYPICAL USE

Connect a chart recorder to the analog output to monitor drift of the input *signal over an extended period of time.*

PREAMP OUT

DESCRIPTION

The PREAMP OUT connector can be used to either configure the Model 617 for external feedback or to monitor the output voltage of the electrometer preamp up to $\pm 200V$ (proportional to the input level).

The table below lists the full range output voltages available at the PREAMP OUT and COM terminals. The output is inverted when in amps or coulombs.

WARNING

Hazardous voltage levels may be present on the PREAMP OUT terminal.

FULL RANGE PREAMP OUT LEVELS

FUNCTION	RANGE	PREAMP OUT (Absolute Value)
Volts	200mV	200mV
	2V	2 V
	20V	20 V
	200V	200 V
Amps	2pA, 2nA, 2 μ A, 2mA	200mV
	20pA, 20nA, 20 μ A, 20mA	2 V
	200pA, 200nA, 200 μ A	20 V
Ohms	2k Ω	200mV
	20k Ω - 2G Ω	2 V
	20G Ω	20 V
	200G Ω	200 V
Coulombs	200pC	200mV
	2nC	2 V
	20nC	20 V

OPERATION

External Feedback

1. Turn zero check on.
2. Press the SHIFT button and then the VOLTS button. The VOLTS and AMPS indicator lights will turn on.
3. Connect the external feedback element from the PREAMP OUT binding post to input HI as shown.
4. Apply the signal to the triax input connector.
5. Turn zero check off.

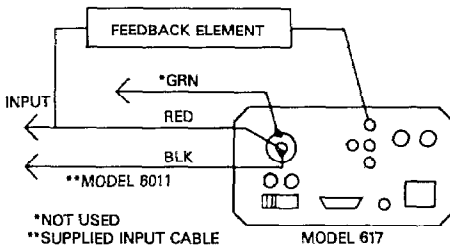

Fig 3. External Feedback

NOTES

1. The negative of the voltage drop across the feedback element will be displayed.
2. To exit the external feedback mode, turn zero check on, remove the feedback element and press any FUNCTION button.

TYPICAL USE

External feedback can be used if non-decade or logarithmic current gain is required, or added coulombs capability is necessary.

V, Ω GUARD

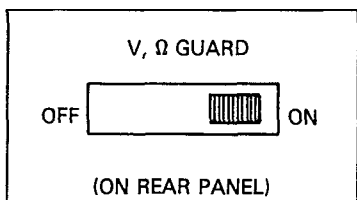

DESCRIPTION

Using the Model 617 in the guarded configuration (V, Ω GUARD switch on) reduces response time and the effects of cable leakage when making volts and ohms measurements. The guard should be used when making resistance measurements above 100M Ω or voltage measurements that have high source resistances. See Fig 4 for guarded measurement corrections.

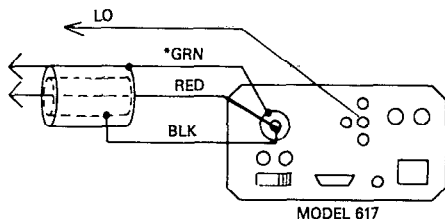

*IF COM TO CHASSIS LINK IS IN, THE GRN LEAD CAN BE USED FOR INPUT LOW. OTHERWISE, THE GRN LEAD IS UNUSED.

**SUPPLIED INPUT CABLE

Fig 4. Guard Measurements

OPERATION

WARNING

Hazardous voltage may be present on the inner shield of triax input connector (black test lead) when V, Ω GUARD is on.

1. Turn zero check on.
2. Place the V, Ω GUARD switch (on rear panel) to the on position.
3. Select the volts or ohms function.
4. Select appropriate range or autorange.
5. Connect input as shown in the illustration.
6. Release zero check and take the reading.

TYPICAL USE

Measure Insulation Resistance—The guard configuration is recommended to allow quick and accurate measurements regardless of cable capacitance or cable leakage.

EXTERNAL TRIGGER INPUT

DESCRIPTION

When the Model 617 is in the single trigger mode, external trigger pulses can be used to initiate measurement conversions. Each pulse will trigger one reading. The external trigger requires a falling edge, debounced pulse at TTL logic level (see Figure 5). A debounced switch can be connected to the EXTERNAL TRIGGER input and used to trigger readings. Every time the switch is closed, one reading will be triggered.

OPERATION

1. Set the Model 617 to the single trigger mode (see TRIG).
2. Input an appropriate debounced trigger pulse source to the EXTERNAL TRIGGER INPUT.

NOTE:

Trigger pulses that are not debounced will cause trigger errors (t Err).

TYPICAL USE

Have a programmable source trigger the Model 617 to take a reading when the source outputs a new level.

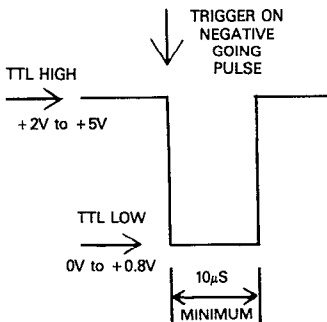

Fig 5. Trigger Pulse Specifications

METER COMPLETE OUTPUT

The METER COMPLETE OUTPUT is a 400 μ sec wide positive going pulse that signifies completion of the measurement cycle. The meter complete line can be used to trigger another instrument or to inform an instrument that the measurement has been completed.

OPERATION

Using an appropriate cable, connect the METER COMPLETE OUTPUT of the Model 617 (located on rear panel) to the external trigger input of another instrument.

TYPICAL USES

1. *Trigger a scanner to switch to the next available channel when the Model 617 measurement cycle has been completed.*
2. *Trigger a programmable source to output the next programmed level when the Model 617 measurement cycle has been completed.*

IEEE-488 PROGRAMMING

Function:	F0 = Volts F1 = Amps F2 = Ohms F3 = Coulombs F4 = External Feedback F5 = V/I																																																																																																		
Range:																																																																																																			
	<table border="1"><thead><tr><th></th><th>Volts</th><th>Amps</th><th>Ohms</th><th>Coul</th><th>X Fdbk</th><th>V/I</th></tr></thead><tbody><tr><td>R0 =</td><td>Auto on</td><td>Auto on</td><td>Auto on</td><td>Auto on</td><td>Auto on</td><td>Auto on</td></tr><tr><td>R1 =</td><td>200mV</td><td>2 pA</td><td>2 kΩ</td><td>200pC</td><td>200mV</td><td>200TΩ</td></tr><tr><td>R2 =</td><td>2 V</td><td>20 pA</td><td>20 kΩ</td><td>2nC</td><td>2 V</td><td>20TΩ</td></tr><tr><td>R3 =</td><td>20 V</td><td>200 pA</td><td>200 kΩ</td><td>20nC</td><td>20 V</td><td>2TΩ</td></tr><tr><td>R4 =</td><td>200 V</td><td>2 nA</td><td>2MΩ</td><td>20nC</td><td>20 V</td><td>200GΩ</td></tr><tr><td>R5 =</td><td>200 V</td><td>20 nA</td><td>20MΩ</td><td>20nC</td><td>20 V</td><td>20GΩ</td></tr><tr><td>R6 =</td><td>200 V</td><td>200 nA</td><td>200MΩ</td><td>20nC</td><td>20 V</td><td>2GΩ</td></tr><tr><td>R7 =</td><td>200 V</td><td>2 μA</td><td>2GΩ</td><td>20nC</td><td>20 V</td><td>200MΩ</td></tr><tr><td>R8 =</td><td>200 V</td><td>20 μA</td><td>20GΩ</td><td>20nC</td><td>20 V</td><td>20MΩ</td></tr><tr><td>R9 =</td><td>200 V</td><td>200 μA</td><td>200GΩ</td><td>20nC</td><td>20 V</td><td>2MΩ</td></tr><tr><td>R10 =</td><td>200 V</td><td>2mA</td><td>200GΩ</td><td>20nC</td><td>20 V</td><td>200KΩ</td></tr><tr><td>R11 =</td><td>200 V</td><td>20mA</td><td>200GΩ</td><td>20nC</td><td>20 V</td><td>200KΩ</td></tr><tr><td>R12 =</td><td>Auto off</td><td>Auto off</td><td>Auto off</td><td>Auto off</td><td>Auto off</td><td>Auto off</td></tr></tbody></table>		Volts	Amps	Ohms	Coul	X Fdbk	V/I	R0 =	Auto on	Auto on	Auto on	Auto on	Auto on	Auto on	R1 =	200mV	2 pA	2 k Ω	200pC	200mV	200T Ω	R2 =	2 V	20 pA	20 k Ω	2nC	2 V	20T Ω	R3 =	20 V	200 pA	200 k Ω	20nC	20 V	2T Ω	R4 =	200 V	2 nA	2M Ω	20nC	20 V	200G Ω	R5 =	200 V	20 nA	20M Ω	20nC	20 V	20G Ω	R6 =	200 V	200 nA	200M Ω	20nC	20 V	2G Ω	R7 =	200 V	2 μ A	2G Ω	20nC	20 V	200M Ω	R8 =	200 V	20 μ A	20G Ω	20nC	20 V	20M Ω	R9 =	200 V	200 μ A	200G Ω	20nC	20 V	2M Ω	R10 =	200 V	2mA	200G Ω	20nC	20 V	200K Ω	R11 =	200 V	20mA	200G Ω	20nC	20 V	200K Ω	R12 =	Auto off	Auto off	Auto off	Auto off	Auto off	Auto off
	Volts	Amps	Ohms	Coul	X Fdbk	V/I																																																																																													
R0 =	Auto on	Auto on	Auto on	Auto on	Auto on	Auto on																																																																																													
R1 =	200mV	2 pA	2 k Ω	200pC	200mV	200T Ω																																																																																													
R2 =	2 V	20 pA	20 k Ω	2nC	2 V	20T Ω																																																																																													
R3 =	20 V	200 pA	200 k Ω	20nC	20 V	2T Ω																																																																																													
R4 =	200 V	2 nA	2M Ω	20nC	20 V	200G Ω																																																																																													
R5 =	200 V	20 nA	20M Ω	20nC	20 V	20G Ω																																																																																													
R6 =	200 V	200 nA	200M Ω	20nC	20 V	2G Ω																																																																																													
R7 =	200 V	2 μ A	2G Ω	20nC	20 V	200M Ω																																																																																													
R8 =	200 V	20 μ A	20G Ω	20nC	20 V	20M Ω																																																																																													
R9 =	200 V	200 μ A	200G Ω	20nC	20 V	2M Ω																																																																																													
R10 =	200 V	2mA	200G Ω	20nC	20 V	200K Ω																																																																																													
R11 =	200 V	20mA	200G Ω	20nC	20 V	200K Ω																																																																																													
R12 =	Auto off	Auto off	Auto off	Auto off	Auto off	Auto off																																																																																													
Zero Check:	C0 = Off C1 = On																																																																																																		
Zero Correct:	Z0 = Off Z1 = On																																																																																																		
Suppress:	N0 = Off N1 = On																																																																																																		
Display:	D0 = Electrometer D1 = Voltage Source																																																																																																		
Read Mode:	B0 = Electrometer B1 = Data Store* B2 = Highest (Max) Buffered Reading B3 = Lowest (Min) Buffered Reading B4 = Voltage Source *See page 42 for program example.																																																																																																		

Data Store Control:	Q0 = Every Reading Q1 = 1 reading per second. Q2 = 1 reading per 10 seconds. Q3 = 1 reading per minute. Q4 = 1 reading per 10 minutes. Q5 = 1 reading per hour. Q6 = Every time TRIG button is pressed. Q7 = Off
V-Source Value:	$V \pm n.nnnnnE \pm nn$ n = Voltage Source Value
V-Source Operate:	O0 = Off O1 = On
Calibration Value:	$A \pm n.nnnnnE \pm nn$ A = Calibration Value
Store:	L1 = Store Calibration Constants
*Trigger:	T0 = Continuous, Talk T1 = Single, Talk T2 = Continuous, GET T3 = Single, GET T4 = Continuous, "X" T5 = Single, "X" T6 = Continuous, External T7 = Single, External *Trigger always starts a new reading, regardless of mode (single/continuous).
Status:	U0 = Send machine status word. U1 = Send error status word. U2 = Send data status word.
Data Format:	G0 = Send prefix with data. G1 = Do not send prefix with data. G2 = Send prefix and buffer address with data (if in B1).
SRQ:	M0 = Clear SRQ Mask M1 = Reading Overflow M2 = Buffer Full M8 = Reading Done M16 = Ready M32 = Error Example: M10 programs the 617 to SRQ when a reading is done or the buffer is full.

EOI:	K0 = Send EOI and hold off on "X". K1 = Do not send EOI and hold off on "X". K2 = Send EOI and no hold off on "X". K3 = Do not send EOI and no hold off on "X".
Terminator:	Y = No terminator character. Ym = One terminator character. Ymn = Two terminator characters.
*Execute:	X = Execute Device-Dependent Commands *Use "X" to force a sequence. Example: To zero the instrument, send C1XZ1XC0X.

TRIGGER TO FIRST BYTE OUT: 350ms.

POWER UP DEFAULT CONDITIONS

MODE	STATUS (see machine status word)
Function	F0 = Volts
Range	R0 = Autorange
Zero Check	C1 = On
Zero Correct	Z0 = Off
Suppress	N0 = Off
Trigger	T6 = Continuous, External
V-Source Operate	O0 = Off
Read Mode	B0 = Electrometer
Data Format	G0 = Send prefix with data
Display	D0 = Electrometer
Data Store Control	Q7 = Off
SRQ	M0 = Clear SRQ mask
EOI	K0 = Send EOI and hold off on "X"
Terminator	Y0 = CR LF
V-Source Value	V0 = 0 Volts
Status	U not active
Cal Value	A not active

DATA FORMAT

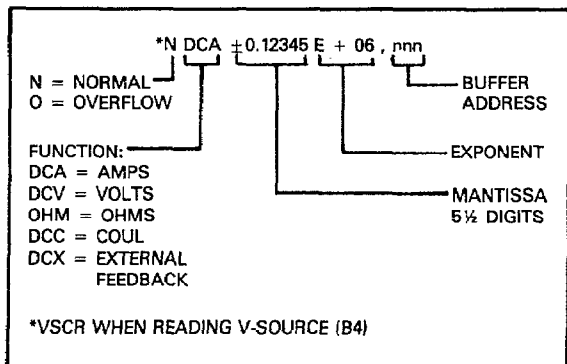

STATUS BYTE

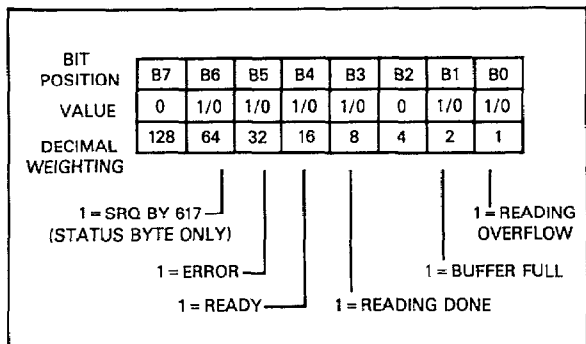

STATUS WORDS

Machine Status (U0)

617 F R R C Z N T O B G D Q M M K Y Y 0 0 0 1 0 0 6 0 0 0 0 7 0 0 0 = :
--

(Default Conditions Shown)

Error Status (U1)

617	IDDC	IDDCO	NO REMOTE	—	TRIGGER OVERRUN	NUMBER	—	—	—
	0 or 1	0 or 1	0 or 1	0	0 or 1	0 or 1	0	0	0

0 = FALSE

1 = TRUE

EXAMPLE: 617010000000 = IDDCO ERROR

Data Status (U2)

617	BUFFER FULL	—	Z	N	TEMP CAL	V-SOURCE OVERLOAD	—	—	—
	0 or 1	0	0 or 1	0 or 1	0 or 1	0 or 1	0	0	0

0 = FALSE

1 = TRUE

EXAMPLE: 617100000000 = BUFFER FULL

IEEE ADDRESS SELECTION

A front panel program is used to display and change the IEEE-488 primary address of the Model 617. See page 26 for instructions.

TALK ONLY OPERATION

DESCRIPTION

Talk only may be used to send data to a listen only device such as a printer. Data may be sent with the prefix (i.e. NDCA) or without the prefix. When the Model 617 is in the talk only mode, it ignores commands given over the bus. The talk only mode is enabled through a front panel program. The default talk rate is three readings per second (every reading). However, a different talk rate can be selected.

OPERATION

1. Select Program. Press and release the SELECT button until IEEE is displayed.
2. Select Talk Only Mode. Adjust the display, using the ADJUST buttons to read 40 for talk only mode with prefix or to 41 for talk only mode without prefix.
3. Store Program. Press the SHIFT button and then the SELECT EXIT button.
4. To select a different talk rate:
 - A. Press and hold in the Data Store ON/OFF button. The following talk rates scroll on the display:
 - r = 0 (every reading)
 - r = 1 (1 reading per second)
 - r = 2 (1 reading per 10 seconds)
 - r = 3 (1 reading per minute)
 - r = 4 (1 reading per 10 minutes)
 - r = 5 (1 reading per hour)
 - r = 6 (1 reading every time TRIG button is pressed)
 - B. Release the ON/OFF button when the desired talk rate is displayed.

NOTE: The instrument remains in the selected talk rate until a new rate is selected, the data store cycle is turned off (DATA STORE indicator light off) or power is cycled.

PROGRAMS

The following programs are designed to be a simple aid to the user. They are not intended to suit specific needs. Detailed programming information can be found in the manual.

The first program demonstrates how to read the contents of the buffer (data store) using the HP-85 computer. All 100 readings stored in the buffer will be displayed.

The rest of the programs display one reading at the output of the controller. Each program provides an ASCII string variable output of the form:

NDCA + 0.00000 + 0 CR LF

The note at the end of each program indicates modifications to provide a numeric variable (A) in exponential form:

+ 0.00000

DATA STORE OPERATION USING HP-85

The following program will enable data store (buffer) operation and obtain and display 100 readings on the computer CRT.

DIRECTIONS

1. Using the front panel program feature, set the primary address on the Model 617 to 27.
2. Connect the Model 617 to the HP82937A IEEE interface.
3. Enter the following program using the END LINE key after each line is typed.
4. Press the HP-85 RUN key. The program will enable the buffer, wait for the buffer to fill, turn on the buffer output, and then request and display all 100 readings.

PROGRAM

COMMENTS

10 DIM A\$(25)	
20 REMOTE 727	Send remote enable.
30 OUTPUT 727;"Q0X"	Enable buffer at conversion rate.
40 S=SPOLL (727)	Serial Poll the 617.
50 IF NOT BIT(S,1) THEN 40	If buffer not full, wait.
60 OUTPUT 727;"B1G2X"	Set read mode to buffer.
70 FOR I=1 TO 100	Loop 100 times.
80 ENTER 727;A\$	Get a buffer reading.
90 DISP A\$	Display it.
100 NEXT I	Loop back and get next reading
110 END	

IBM XT or PC (Keithley 8573 GPIB Interface)

The following program sends a command string to the Model 617 from an IBM PC or XT computer and displays the instrument reading on the CRT. The computer must be equipped with a Keithley Instruments Model 8573 GPIB IEEE interface and the DOS 2.0 operating system. The GPIB software and hardware must be configured per the Keithley Instruments Model 8573 Instruction Manual.

DIRECTIONS

1. Using the front panel program feature, set the primary address of the Model 617 to 27.
2. With the power off, connect the Model 617 to the IEEE-488 interface installed in the IBM computer.
3. Type in the command `BASICA` on the IBM keyboard to get into the IBM interpretive `BASICA` language.
4. Place the interface software disc in the default drive, type `LOAD "DECL"`, and press the return key.
5. Enter the following program into the computer, pressing the return key after each line is type. Lines 1-6 are part of the `DECL` program previously loaded and need not be typed in. However, lines 1 and 2 will have to be altered. See the Model 8573 Instruction Manual.
6. Run the program and type in the desired command string when prompted. For example: to place the Model 617 into the one shot on talk trigger mode and in the $2\mu\text{A}$ range, type in `F1R7T1X` and press the return key.
7. The display will show the Model 617 reading string on the CRT. For example, when the Model 617 is in zero check, the display will read `NDCA + 0.00000E-06`.
8. To exit the program type `EXIT` and press return.

PROGRAM**COMMENTS**

10 CLS	
20 NA\$ = "GPIB0":CALL IBFIND (NA\$,BRD0%)	Find the board number.
30 NA\$ = "DEV0":CALL IBFIND (NA\$,M617%)	Find the 617 number.
35 V% = 8:H102:CALL IBPOKE (BRD0%,V%)	Set timeout delays.
40 V% = 27:CALL IBPAD (M617%,V%)	Change to primary address 27.
50 V% = 1:CALL IBSRE (BRD0%,V%)	Set REN true.
60 INPUT"COMMAND";CMD\$	Prompt for command string.
70 If CMD\$ = "EXIT" THEN 150	See if program is to be halted.
80 If CMD\$ = " " THEN 60	If null command string, go back and get another.
90 CALL IBWRT(M617%,CMD\$)	Address 617 to listen and send command string.
100 RD\$ = SPACE\$(50)	Assign reading input buffer.
110 CALL IBRD(M617%,RD\$)	Address 617 to Talk and input reading string.
120 RD\$ = LEFT\$(RD\$,IBCNT%)	Trim string to proper size.
130 PRINT RD\$	Display the reading on the CRT.
140 GOTO 60	Repeat.
150 V% = 0:CALL IBONL (BRD0%,V%)	Close the board file.
160 CALL IBONL(M617%,V%)	Close the instrument file.
170 END	

NOTE: Lines 1-6 of this program are not shown and need not be typed in. They are contained in the floppy disc. When the command LOAD"DECL" is entered these lines are already there.

NOTE: If conversion to numeric variable is desired, change lines 120 and 130 as follows:

```
120 RD = VAL(MID$(RD$,5,16))
130 PRINT RD
```

APPLE II (APPLE Interface)

The following program obtains one reading from the Model 617 Electrometer and displays the reading on the APPLE II screen, using an APPLE IEEE-488 interface.

DIRECTIONS

1. Using the front panel program feature, set the primary address of the Model 617 to 27.
2. Connect the Model 617 to the APPLE II and APPLE IEEE-488 interface.
3. Enter the following program using the RETURN key after each line.
4. Type in RUN and depress the RETURN key.
5. The display will read "TEST SETUP".
6. To program the Model 617 to the $2\mu\text{A}$ range and take a reading, type in F1R7T1X and depress the RETURN key.
7. The display will read NDCA + 0.00000E - 06 when the Model 617 is in zero check.

PROGRAM	COMMENTS
20 Z\$ = CHR\$(26)	Terminator.
30 INPUT "TEST SETUP?";B\$	Enter programming command. Example: $2\mu\text{A}$ range = F1R7T1X
40 PR#3	Send output to IEEE bus.
50 IN#3	Get input from IEEE bus.
60 PRINT "RA"	Turn remote on.
70 PRINT "WT";Z\$;B\$	Write B\$ to 617.
80 PRINT "LF1"	Linefeed on.
90 PRINT "RD"; CHR\$(91);Z\$; INPUT " ";A\$	Read data from 617.
100 PRINT "UT"	
110 PR#0	Send output to CRT.
120 IN#0	Get input from keyboard.
130 PRINT A\$	
140 GO TO 30	Repeat.

NOTE: If conversion to numeric variable is needed, add the following:

```
134 A = VAL(MID$(A$,5,16))
136 PRINT A
```

HP 85

The following program obtains one reading from the Model 617 Electrometer and displays the reading on the HP-85 CRT screen, using the 82937A GPIB interface and an I/O ROM.

DIRECTIONS

1. Using the front panel program feature, set the primary address on the Model 617 to 27.
2. Connect the Model 617 to the HP82937A IEEE interface.
3. Enter the following program using the END LINE key after each line is typed.
4. Depress the RUN key.
5. The display will read "TEST SETUP".
6. To program the Model 617 to the $2\mu\text{A}$ range and take a reading, type in F1R7T1X and depress the END LINE key.
7. The display will read NDCA + 0.00000E - 06 when the Model 617 is in zero check.

PROGRAM

COMMENTS

10 DIM A\$(25), B\$(25)	
20 REMOTE 727	Set to remote.
30 DISP "TEST SETUP"	Prompt for test setup.
40 INPUT B\$	
50 OUTPUT 727;B\$	Program the 617
60 ENTER 727;A\$	Get data from 617.
70 DISPA\$	
80 GO TO 30	Repeat
90 END	

NOTE: If conversion to numeric variable is needed, change line 70 as follows:

```
70 DISP VAL(A$(5))
```

HP 9825A

The following program obtains one reading from the Model 617 Electrometer and displays the reading on the HP 9825A using a 98034A HP-IB interface and a 9872A extended I/O ROM.

DIRECTIONS

1. Using the front panel program feature, set the primary address of the Model 617 to 27.
2. Connect the Model 617 to the HP 9825A and the 98034A HP-IB interface.
3. Enter the following program using the STORE key after each line is typed. Line numbers are automatically assigned by the 9825A.
4. Depress the RUN key.
5. The display will read "TEST SETUP".
6. To program the Model 617 to the $2\mu\text{A}$ range and take a reading type in F1R7T1X and depress the CONT key.
7. The print-out will read NDCA + 0.00000E-06 when the Model 617 is in zero check.

PROGRAM

COMMENTS

0 dim A\$(20),B\$(20)	Dimension data strings.
1 dev"617",727	Define Model 617 address 27.
2 rem"617"	Set to remote.
3 ent"TEST SETUP",B\$	Enter programming command. (Example: $2\mu\text{A}$ range = F1R7T1X)
4 wrt"617",B\$	Output program command to Model 617 via IEEE bus.
5 red"617",A\$	Read data from Model 617 via IEEE bus.
6 prt A\$	Print data on hard copy printer.
7 gto 3	Repeat

NOTE: If conversion to numeric variable is desired, omit line 6 and 7 and substitute:

6 "e"→ A\$(13,13);flt5	Convert to numeric variable.
7 prt val(A\$(5))	
8 gto 3	Repeat.

HP 9816

The following program sends a command string to the Model 617 Electrometer, reads data and displays the data on the HP 9816 CRT, using BASICA 2.0.

DIRECTIONS

1. Using the front panel program feature, set the primary address of the Model 617 to 27.
2. With the power off, connect the Model 617 to the HP 9816 and HP 82937A GPIB interface.
3. Type EDIT and press the EXEC key.
4. Enter the following program using the ENTER key after each line is typed.
5. Press the HP 9816 RUN key.
6. The display will read "TEST SETUP".
7. To program the Model 617 to the 2 μ A range and to take a reading, type in F1R7T1X and press the ENTER key.
8. The display will read NDCA + 0.00000E-06 when the Model 617 is in zero check.

PROGRAM	COMMENTS
10 REMOTE 727	Set to remote.
20 INPUT "TEST SETUP",A\$	Prompt for test setup.
30 OUPUT 727;A\$	Send command string to 617.
40 ENTER 727;B\$	Get data string from 617.
50 PRINT B\$	Display data string.
60 GO TO 20	Repeat.
70 END	

NOTE: If conversion to numeric variable is desired, change lines 40 and 50 as follows:

```
40 ENTER 727;B
50 PRINT B
```

DEC LSI 11

The following program obtains one reading from the Model 617 Electrometer and displays the reading on the DEC LSI 11 microcomputer CRT terminal. The LSI 11 must be configured with 16k words of RAM and an IBV 11 IEEE interface. The software must be configured with IB software as well as the FORTRAN and the RT 11 operating system.

DIRECTIONS

1. Using the front panel program features, set the primary address of the Model 617 to 27.
2. Connect the Model 617 to the IBV 11 IEEE cable.
3. Enter the following program, using the editor under RT 11 and the name IPHILD.
4. Compile using the fortran compiler as follows: FORTRAN IPHILD.
5. Link with the system and IB libraries as follows: LINK IPHILD,IBLIB.
6. Type RUN IPHIL and depress the RETURN key.
7. The display will read "ENTER ADDRESS".
8. Type in 27 and depress the RETURN key.
9. The display will read "TEST SETUP".
10. To program the Model 617 to the $2\mu\text{A}$ range and take a reading, type in F1R7T1X and depress the RETURN key.
11. The display will read NDCA + 0.00000E - 06 when the Model 617 is in zero check.

PROGRAM**COMMENTS**

```
INTEGER*2 PRIADR
LOGICAL*1 MSG(80),INPUT(80)
DO 2 I = 1,10
CALL IBSTER(I,0)
2 CONTINUE
CALL IBSTER (15,5)
CALL IBTIMO (120)

CALL IBTERM ("10)
CALL IBREN
4 TYPE 5
5 FORMAT (1X,'ENTER ADDRESS',&)
ACCEPT 10, PRIADR
10 FORMAT (2I4)
12 TYPE 15
15 FORMAT (1X,'TEST SETUP',&)
CALL GETSTR (5,MSG,72)
CALL IBSEDI (MSG, -1,PRIADR)
18 I = IBRECV (INPUT,80,PRIADR)
INPUT (I + 1) = 0
CALL PUTSTR (7,INPUT,'0')
CALL IBUNT
GO TO 12
END
```

!Turn off IB errors.

!Allow 5 error 15's.

!Allow 1 second bus time-out.

!Set LF as terminator.

!Turn remote on.

!Input the address 27.

!Prompt for the test setup.

!Get the test setup.

!Program the 617.

!Untalk the 617.

!Repeat

PET/CBM 2001

The following program obtains one reading from the Model 617 Electrometer and displays the reading on the PET/CBM 2001 screen.

DIRECTIONS

1. Using the front panel feature, set the primary address of the Model 617 to 27.
2. Connect the Model 617 to the PET/CBM 2001 IEEE interface.
3. Enter the following program using the RETURN key after each line.
4. Type RUN and depress the RETURN key.
5. The display will read "TEST SETUP".
6. To program the Model 617 to the $2\mu\text{A}$ range and take a reading, type in F1R7T2X and depress the RETURN key.
7. The display will read NDCA + 0.00000E - 06 when the Model 617 is in zero check.

PROGRAM	COMMENTS
10 OPEN 6,27	Open file 6, primary address 27
20 INPUT "TEST SETUP";B\$	Enter programming command (Example: $2\mu\text{A}$ range = F1R7T2X)
30 PRINT#6,B\$	Output to IEEE bus.
40 INPUT#6,A\$	Read data from Model 617 via IEEE bus.
50 IF ST = 2 THEN 40	If time out, input again.
60 PRINT A\$	Print data
70 GO TO 20	Repeat

NOTE: If conversion to numeric variable is desired, omit line 70 and type the following:

70 A = VAL(MID\$(A\$,5,15))	Convert to numeric variable.
80 PRINT "A=" ;A	
90 GO TO 20	Repeat

KEITHLEY

Test Instrumentation Group
28775 Aurora Road / Cleveland, Ohio 44139
