

ELGAR



**VARIABLE
FREQUENCY
OSCILLATORS**

SERIES 400V

ELGAR ELECTRONICS CORPORATION

9250 Brown Deer Road
San Diego, CA 92121-2294
1-800-733-5427
Tel: (858) 450-0085
Fax: (858) 458-0267
Email: sales@elgar.com
www.elgar.com

©1984 by Elgar Electronics Corporation

This document contains information proprietary to Elgar Electronics Corporation. The information contained herein is not to be duplicated or transferred in any manner without prior written permission from Elgar Electronics Corporation.

January 1984

Document No. 604-054-96

ELGAR TWO-YEAR WARRANTY

Elgar Electronics Corporation (hereinafter referred to as Elgar) warrants its products to be free from defects in material and workmanship. This warranty is effective for two years from the date of shipment of the product to the original purchaser. Liability of Elgar under this warranty shall exist provided that:

- the Buyer exposes the product to normal use and service and provides normal maintenance on the product;
- Elgar is promptly notified of defects by the Buyer and that notification occurs within the warranty period;
- the Buyer receives a Return Material Authorization (RMA) number from Elgar's Repair Department prior to the return of the product to Elgar for repair, phone 800-73-ELGAR (800-733-5427), ext. 2295;
- the Buyer returns the defective product in the original, or equivalent, shipping container;
- if, upon examination of such product by Elgar it is disclosed that, in fact, a defect in materials and/or workmanship does exist, that the defect in the product was not caused by improper conditions, misuse, or negligence; and,
- that Elgar QA seal and nameplates have not been altered or removed and the equipment has not been repaired or modified by anyone other than Elgar authorized personnel.

This warranty is exclusive and in lieu of all other warranties, expressed or implied, including, but not limited to, implied warranties of merchantability and fitness of the product to a particular purpose. Elgar, its agents, or representatives shall in no circumstance be liable for any direct, indirect, special, penal, or consequential loss or damage of any nature resulting from the malfunction of the product. Remedies under this warranty are expressly limited to repair or replacement of the product.

CONDITIONS OF WARRANTY

- To return a defective product, contact an Elgar representative or the Elgar factory for an RMA number. Unauthorized returns will not be accepted and will be returned at the shipper's expense.
- For Elgar products found to be defective within thirty days of receipt by the original purchaser, Elgar will absorb all ground freight charges for the repair. Products found defective within the warranty period, but beyond the initial thirty-day period, should be returned prepaid to Elgar for repair. Elgar will repair the unit and return it by ground freight pre-paid.
- Normal warranty service is performed at Elgar during the weekday hours of 7:30 am to 4:30 pm Pacific time. Warranty repair work requested to be accomplished outside of normal working hours will be subject to Elgar non-warranty service rates.
- Warranty field service is available on an emergency basis. Travel expenses (travel time, per diem expense, and related air fare) are the responsibility of the Buyer. A Buyer purchase order is required by Elgar prior to scheduling.
- A returned product found, upon inspection by Elgar, to be in specification is subject to an inspection fee and applicable freight charges.
- Equipment purchased in the United States carries only a United States warranty for which repair must be accomplished at the Elgar factory.

ELGAR

Committed to Quality...Striving for Excellence

TABLE OF CONTENTS

SECTION I
GENERAL INFORMATION

1-1	INTRODUCTION	1-1
1-3	SCOPE OF MANUAL	1-1
1-5	MODEL NUMBERING SYSTEM	1-1
1-7	GENERAL DESCRIPTION	1-2
1-10	RESISTANCE PROGRAMMING	1-2
1-14	TANDEM OPERATION	1-2
1-18	SPECIFICATIONS	1-2

SECTION II
PRELIMINARY INSPECTION AND OPERATION

2-1	INSPECTION UPON RECEIPT	2-1
2-5	INSTALLATION	2-1
2-7	OPERATION	2-1
2-9	OPERATION WITH EXTERNAL SYNC	2-1
2-11	INTERCONNECTIONS FOR TWO OR THREE PHASE OPERATION	2-2
2-14	EXTERNAL SIGNAL	2-2

SECTION III
THEORY OF OPERATION

3-1	OSCILLATOR CIRCUIT	3-1
3-4	TWO-PHASE AND THREE-PHASE CIRCUIT	3-1
3-6	OSCILLATOR POWER SUPPLIES	3-2

SECTION IV
MAINTENANCE

4-1	SERVICE INFORMATION	4-1
4-3	FACTORY REPAIR	4-1
4-5	SHIPPING DAMAGE	4-1
4-7	FREQUENCY CALIBRATION – DECADE DIAL OSCILLATORS	4-1
4-11	FREQUENCY CALIBRATION – CONTINUOUSLY-VARIABLE OSCILLATOR	4-1
4-15	PHASE ANGLE CALIBRATION	4-2
4-17	AMPLITUDE CALIBRATION	4-2
4-19	SIGNAL TRACING	4-2
4-21	CIRCUIT BOARD COMPONENT LOCATION	4-2

TABLE OF CONTENTS (Continued)

SECTION V
DIAGRAMS

5-1	GENERAL	5-1
5-3	DIAGRAMS	5-1

SECTION VI
REPAIR PARTS LIST

6-1	GENERAL	6-1
6-3	SPARE PARTS ORDERING	6-1

LIST OF TABLES

1-1	Specifications	1-3
-----	--------------------------	-----

LIST OF ILLUSTRATIONS

1-1	Model Numbering System	1-1
2-1	Amplifier 3Ø Wye Configuration	2-2
2-2	Typical Plug-in Oscillator/Power Source Interconnection	2-3
3-1	Oscillator Block Diagram	3-1
3-2	Two and Three Phase Circuit Block Diagram	3-2
3-3	Rear Panel Connections for Two- or Three-Phase Operation	3-3
4-1	Component Location for Model 403V	4-3
4-2	Component Location Diagram for Decade Switch Assembly	4-4
4-3	Component Location Diagram for Model 4641V	4-5
5-1	Schematic Diagram for Decade Dial Oscillators	5-2/5-3
5-2	Schematic Diagram for Single-Band Continuously Variable Oscillators	5-4/5-5
5-3	Schematic Diagram for Dual-Band Continuously Variable Oscillators	5-6/5-7

**SECTION I
GENERAL INFORMATION**

1-1. INTRODUCTION

1-2 The Series 400V variable frequency oscillators are plug-in units which provide frequency determining signals for the Elgar AC Power Sources. Elgar manufactures two types of variable frequency oscillators; the decade dial oscillators which provide digital selection of frequency from 10 to 10990 Hz in three push-button selected ranges, and the narrow range continuously variable oscillators with frequency ranges of 45-70 Hz, 350-450 Hz, and 300-500 Hz. Single-, two- and three phase versions of both types of oscillators are available. The oscillator frequencies are stable and accurate and the signal amplitude is stable, but uncalibrated. The signal amplitude is variable, at the front panel of the associated Elgar AC Power Sources, from zero to the full rated output of the power source.

1-3. SCOPE OF MANUAL

1-4. This manual describes the Elgar Series 400V variable frequency oscillators. It includes specifications, operating instructions, circuit description with circuit diagrams, maintenance information and parts list.

1-5. MODEL NUMBERING SYSTEM

1-6. The decade dial oscillators are designated Model 401V, 402V or 403V, the last digit indicating single-, two- or three-phase capability. The narrow range, continuously variable oscillators are identified by a three-digit number for single-band units and a four-digit number for two-band units. The numbering system is described in Figure 1-1. Frequency digit 3 denotes a frequency range of 300-500 Hz; frequency digit 4 denotes 350-400 Hz; and frequency digit 6 denotes 45-70 Hz.

A. Single Band Identification Model Number:

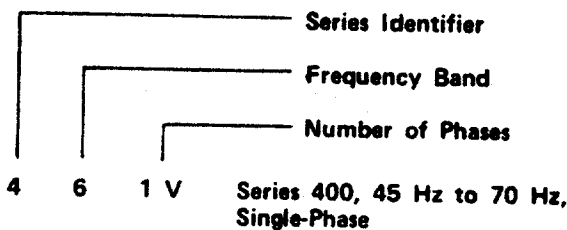

B. Dual Band Identification Model Number:

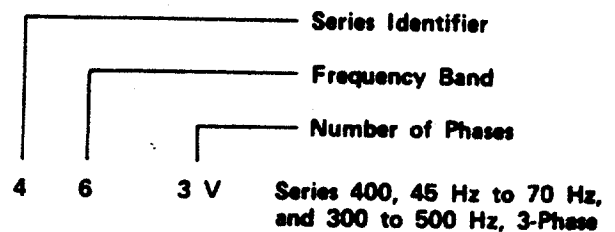

Figure 1-1. Model Numbering System

1-7. GENERAL DESCRIPTION

1-8. The oscillator plugs into the front panel of the Elgar power source and is secured by two captive screws. Frequency output of the decade dial oscillator is selected by three decade switch dials and a vernier potentiometer which provides continuous resolution between the least significant decade frequency steps. Pushbutton switches select ranges of 10-109 Hz, 100-1099 Hz and 1000-10990 Hz.

1-9. Frequency output of the narrow-band continuously variable oscillators is controlled by a calibrated vernier potentiometer on the front panel which gives continuous resolution between the lowest and highest frequencies of the operation frequency band. Two-band instruments have pushbutton selectors on the front panel for high or low frequency band selection. Output frequencies available are:

Low band:	45 Hz to 70 Hz
High band:	350 Hz to 450 Hz or 300 Hz to 500 Hz

1-10. RESISTANCE PROGRAMMING

1-11. When an Elgar Plug-In Oscillator has been equipped for resistance programming the output voltage of the AC Power Source the model number will indicate so by including a "P" at the end of the number.

1-12. Resistance programming is accomplished by connecting an external resistor between pins 11 and 12 of Connector J1, located on the rear panel of the AC Power Source. The value of the resistor is typically at 100 ohms per volt, refer-

enced to the output of the AC Power Source on the 0.0 to 130V range.

1-13. The external resistor is in fact taking the place of the feedback resistor in the operational amplifier circuit of the oscillator. It is important to know that during initial calibration this resistor must be matched to the input resistor of the operational amplifier to obtain a gain of 1. Once this is accomplished the front panel amplitude control may be rotated to the desired full scale output voltage on the AC Voltage Meter located on the front panel of the Power Source. The reading is typically 130V and in effect provides the 100 ohms per volt calibration.

1-14. TANDEM OPERATION

1-15. For all single phase Series 400 Plug-In Oscillators whose model number ends in a T (4X1.XXT) R115, a 475 ohm, 1% resistor and a jumper between pins 9 and 21 have been added for tandem operation.

1-16. For all two or three phase oscillators whose model number ends in a T (4X3.XXT) a jumper has been added between pins 9 and 21 for tandem operation. (Note: R115 is already present.)

1-17. The addition of the jumper between pins 9 and 21 enables the master A0 signal to also be routed to the slave unit allowing the system to be operated in the tandem configuration.

1-18. SPECIFICATIONS

1-19. Specifications for the Series 400V oscillators are listed in Table 1.

Table 1-1. Specifications

OUTPUT SIGNAL AMPLITUDE	Approximately 2 VRMS
HARMONIC DISTORTION	Less than 0.25% of oscillator output
FREQUENCY ACCURACY	
Decade Dial Oscillators	± 1% of set value
Narrow Range Oscillators	± 0.25% of set value
TEMPERATURE COEFFICIENT	
of Output Amplitude	± .02% /°C
of Output Frequency	± .02% /°C

Model	Output Frequencies	Output Configuration
401V	X 1/10 range 10-109.9 Hz	1 Phase
402V	X 1 range 100-1099 Hz	2 Phase
403V	X 10 range 1000-10990 Hz	3 Phase
461V		1 Phase
462V	45-70 Hz	2 Phase
463V		3 Phase
441V		1 Phase
442V	350-450 Hz	2 Phase
443V		3 Phase
431V		1 Phase
432V	300-500 Hz	2 Phase
433V		3 Phase
4641V		1 Phase
4642V	Low Band 45-70 Hz	2 Phase
4643V	High Band 350-450 Hz	3 Phase
4631V		1 Phase
4632V	Low Band 45-70 Hz	2 Phase
4633V	High Band 300-500 Hz	3 Phase

NOTE: External Sync, optional in all models, denoted by ES after model number.

**SECTION II
PRELIMINARY INSPECTION AND OPERATION**

2-1. INSPECTION UPON RECEIPT

2-2. The Elgar plug-in oscillators are aligned, calibrated, and tested prior to shipment. The instrument is therefore ready for immediate use upon receipt. The following checks should be made however, to assure the instrument has suffered no damage during shipment.

2-3. Make a visual inspection of the shipping container prior to accepting the package from the carrier. If extensive damage to the shipping container is evident, a description of the damage should be noted on the carrier's receipt, and signed by the driver or carrier agent. If damage is not apparent until the instrument is unpacked, a claim for concealed damage should be placed with the carrier and all shipping containers and filler material saved for inspection. Forward a report of damage to the Elgar Repair Department, who will provide instructions for repair or replacement of the instrument.

2-4. Visually inspect instrument for physical damage when it is removed from shipping container. Test functional operation of instrument as soon as possible. If damage is evident, or instrument does not function properly, notify the carrier immediately. Carrier's claim agent will prepare a report of damage to be forwarded to the Elgar Repair Department. You will be advised as to the action necessary to have the instrument repaired or replaced.

2-5. INSTALLATION

2-6. The oscillator is quickly and easily installed by plugging it into the space provided on the front

panel of the Elgar power source. When oscillator is fully inserted, and the captive screws secured, the unit is ready for operation.

NOTE

Remove power from amplifier when installing oscillator.

2-7. OPERATION

2-8. After installation in the Elgar power source, the oscillator operates automatically, receiving its power from the power source and requiring only that the front panel controls be set for the desired frequency and range. The amplitude of the power source output is controlled by the AMPLITUDE control on the front panel of the power source. In two- and three range oscillators, off-frequency operation and excessive output amplitude may result if none or more than one of range switch push-buttons are depressed simultaneously.

NOTE

The frequency calibration of the decade dial oscillator is accurate only when the vernier pot is in the CAL position.

2-9. OPERATION WITH EXTERNAL SYNC

2-10. Oscillators with model numbers ending in ES are equipped for external synchronization. The external sync signal should be approximately 10V peak-to-peak either sine or square wave. This signal is transformer isolated in the oscillator to avoid

cross-grounding problems. The external sync terminals are connected to pins 11 and 12 of the Jones S312AB receptacle on the rear panel of the Elgar power source. The phase angle between the power source output and the synchronizing signal is a function of the synchronizing signal amplitude and waveshape and of the difference between the oscillator free-running frequency and the sync signal frequency. This phase angle may be varied somewhat by slightly varying the oscillator tuning. Figure 2-2 illustrates a typical Plug-in Oscillator/AC Power Source interconnection.

2-11. INTERCONNECTIONS FOR TWO OR THREE PHASE OPERATION

2-12. Three-phase oscillators may be installed directly in Elgar three-phase power sources without special connections. Where two-phase or three-phase power sources are made up by stacking two or three of the Elgar single-phase power sources, the oscillator is installed in the A-phase power source. Oscillator signals are carried to the B-phase and C-phase power sources through a cable (furnished with the oscillator) interconnecting the Jones S312AB sockets on the rear panels of the power source. The B-phase and C-phase sources must have Model 400-B and 400-C dummy plug-ins installed to complete the signal interconnection. The front panel AMPLITUDE con-

trol on the A-phase power source acts as a master control to vary all the outputs simultaneously, while the B-phase and C-phase AMPLITUDE controls act merely as balance controls to set the B-phase and C-phase output voltages equal to the A-phase output voltage.

2-13. With those single-phase Elgar power sources which have dual output windings, two power sources may be interconnected for three-phase wye operation. One of the output windings on each of the A-phase and B-phase sources is used for the A-phase and B-phase outputs. The C-phase output is synthesized by inverse series connection of the remaining two windings, as diagrammed in Figure 2-1.

2-14. EXTERNAL SIGNAL

2-15. Single-phase continuously-variable oscillators are equipped with a front-panel closed-circuit jack for external signal operation. A 2-3 VRMS external signal may be introduced by plugging a Switchcraft No. 750 plug into the jack, the closed-circuit jack automatically disconnecting the internal signal. The front panel AMPLITUDE control is effective with the external signal connection.

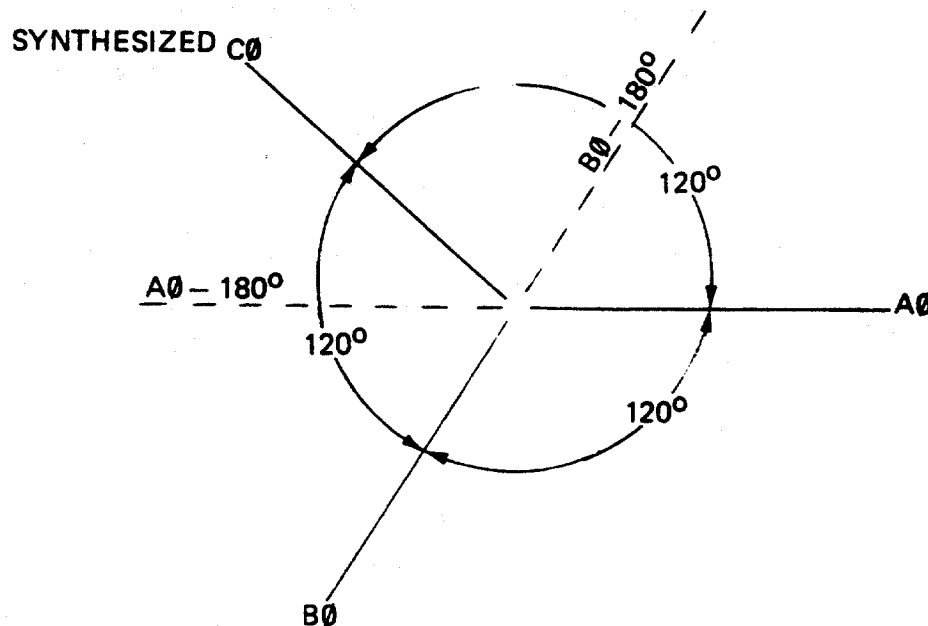

Figure 2-1. 2 Amplifier 3Ø Wye Configuration

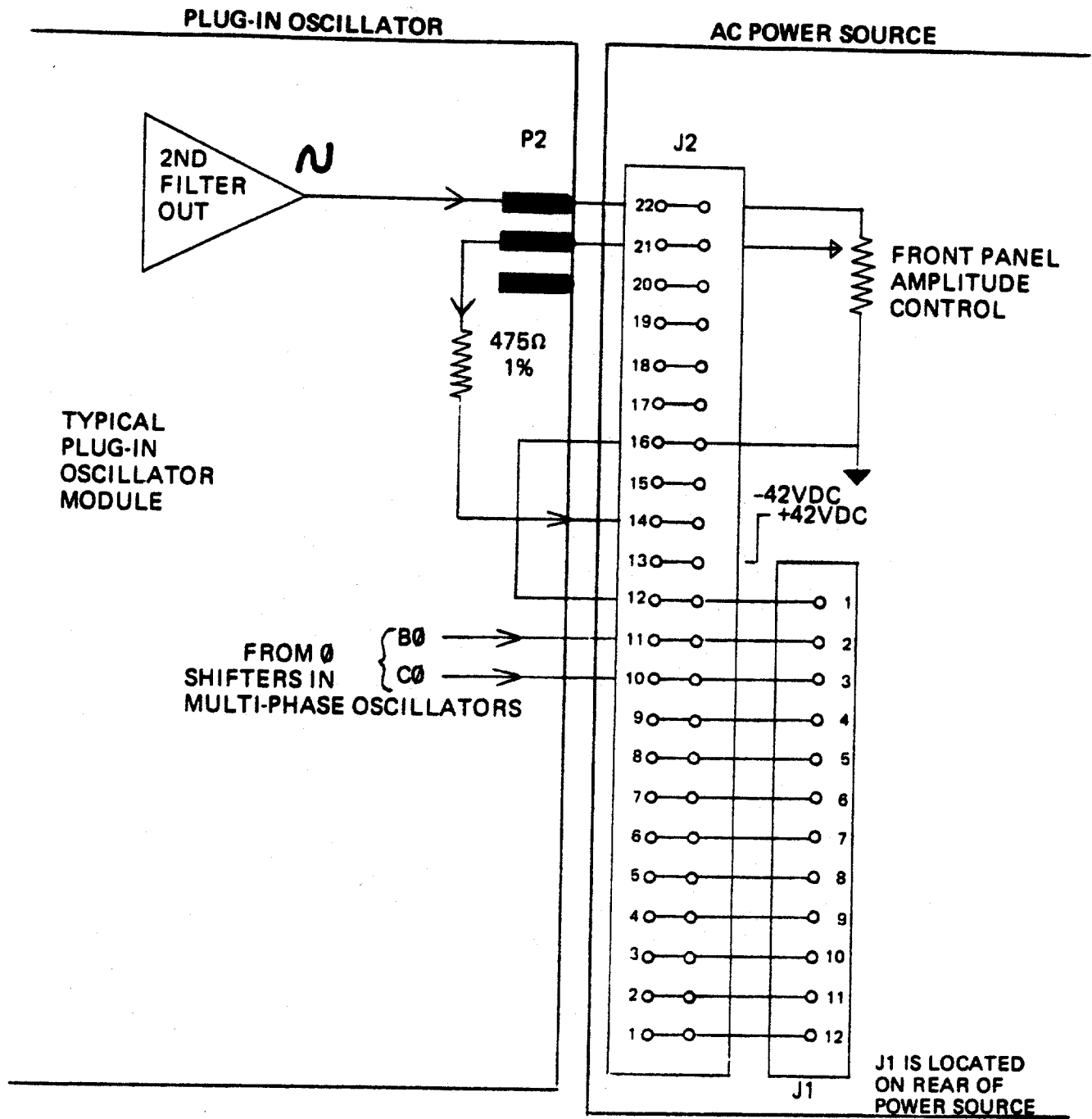

Figure 2-2. Typical Plug-in Oscillator/Power Source Interconnection

SECTION III THEORY OF OPERATION

3-1. OSCILLATOR CIRCUIT

3-2. The oscillator circuit is a modified phase-shift oscillator, as shown in the block diagram (Figure 3-1). The resistance and capacitance tuning components are connected together with operational amplifiers Z101 and Z102 as two cascaded active low-pass filters. Each filter section contributes 90° phase shift at the operating frequency, for a total of 180° . An additional 180° phase shift in the clipper circuitry provides positive feedback to sustain the oscillation. The combination of a stable-amplitude square-wave and the stable gain of the active filters gives a constant output amplitude without requiring auxiliary amplitude-control systems. This oscillator circuit exhibits no turn-on overshoots or ringing in its output signal amplitude. The active filters attenuate the harmonics of the square wave to give less than 0.25% harmonic distortion in the output signal.

3-3. In the decade dial oscillators and the two-band versions of the continuously-variable oscillator, the capacitors in the active filters are selected by push-button switches to determine the frequency range. Frequency variations within the range are accomplished by varying the resistors in the active filters, using decade-switch selected resistors in the decade dial oscillators, and a ganged precision potentiometer in the continuously-variable oscillators.

3-4. TWO-PHASE AND THREE-PHASE CIRCUIT

3-5. In two-phase and three-phase oscillators, the oscillator signal from the AMPLITUDE control arm in the A-phase power amplifier is buffered by unity gain amplifier Z105 and applied to two operational amplifier all-pass phase shifters, Z106 and Z107. In three-phase oscillators, the B-phase signal lags the A-phase signal by 120° and the C-phase signal lags

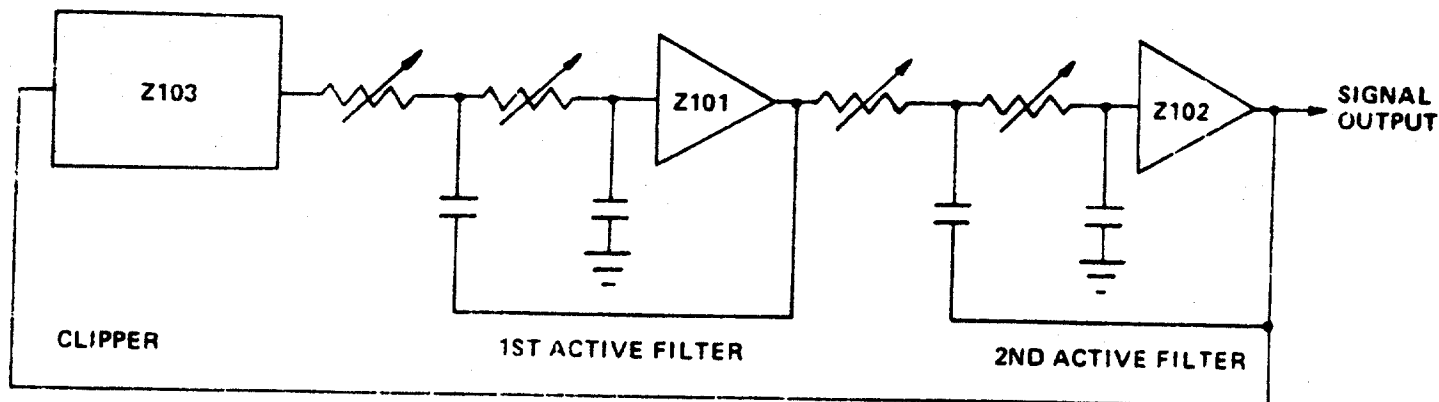

Figure 3-1. Oscillator Block Diagram

the B-phase signal by 120° . In two-phase oscillators, the B-phase signal lags the A-phase signal by 90° and the C-phase components are omitted. The phase-shift capacitors are selected by the push-button frequency-range switches and the variable resistors are ganged with the frequency determining resistors in the oscillator to preserve constant phase shift, regardless of frequency. The B-phase and C-phase signals are connected through the plug-in connector Z101 to the 12-pin Jones S312AB receptacle on the rear of the A-phase power source. Interconnecting cables then carry these signals to the B-phase and C-phase power sources in stacked-amplifier systems (See Figure 3-3).

The A-phase AMPLITUDE control acts as a master control to control the amplitude of all three phases simultaneously. When single-phase power amplifiers are stacked for two- or three-phase power, the B-phase and C-phase amplitude

controls are used only as balance adjustments to set the B-phase and C-phase outputs equal to the A-phase output.

3-6. OSCILLATOR POWER SUPPLIES

3-7. The oscillator circuitry is operated from + and -15 VDC regulated power supplies which are derived from the unregulated + and -42 VDC power supplies in the associated power source. In the +15V power supply, differential pair Q103 and Q104 compare the +15V regulated output to the reference voltage from CR102, developing an error signal to control compound-connected pass transistors Q101 and Q102, R102, R103 and CR101 ensure that the regulator starts when power is applied. R101 limits the fault current if the +15V output is accidentally shorted.

3-8. In the -15V regulator, differential pair Q107 and Q108 develop the error signal by comparing the -15V regulated output to the +15V regulated output. The error signal is used to control compound-connected pass transistors Q106 and Q107. R109 limits the fault current if the -15V output is accidentally shorted.

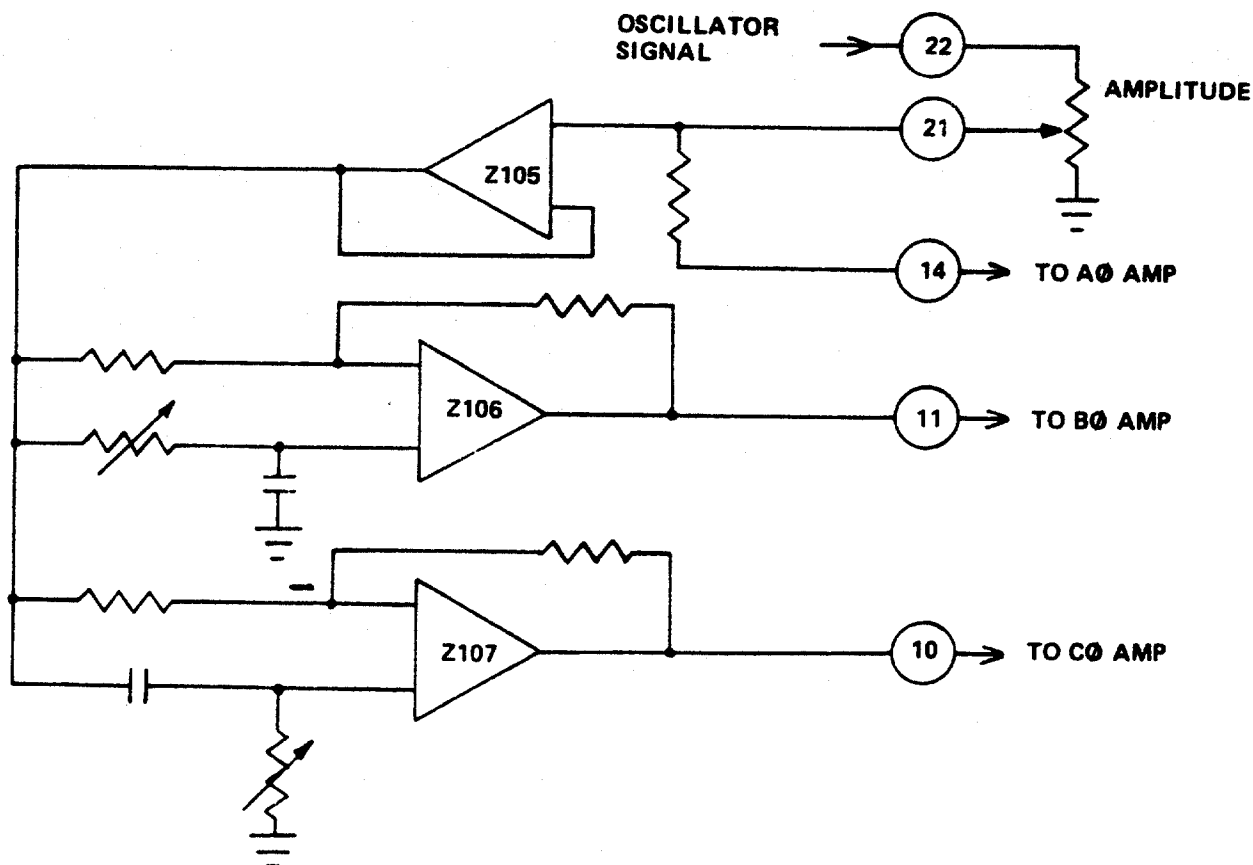
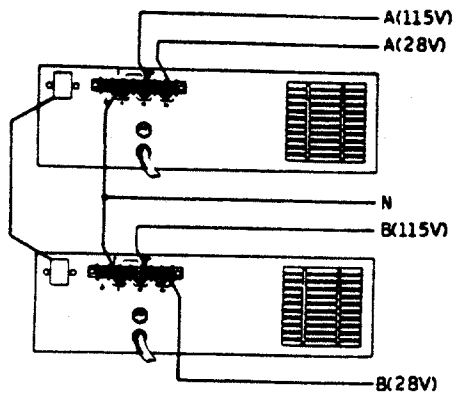
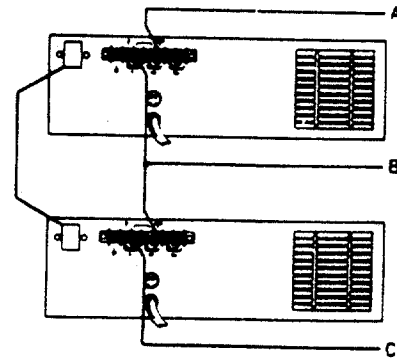

Figure 3-2. Two and Three Phase Circuit Block Diagram

2-PHASE



3-PHASE OPEN-DELTA (115V)



3-PHASE OPEN-DELTA (208V)

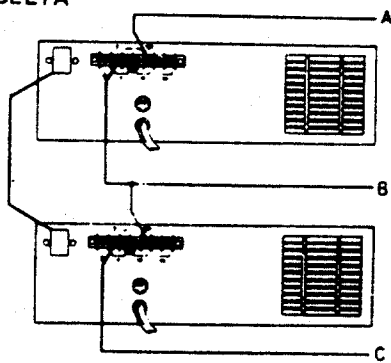

2 AMPLIFIER WYE (115V)

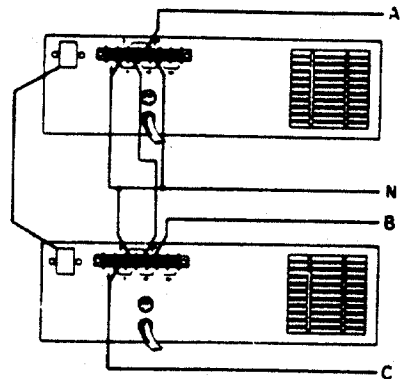

2 AMPLIFIER WYE (28V)

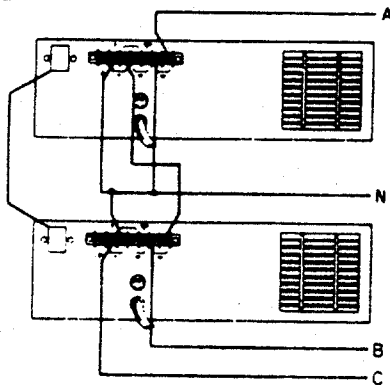

3 AMPLIFIER WYE

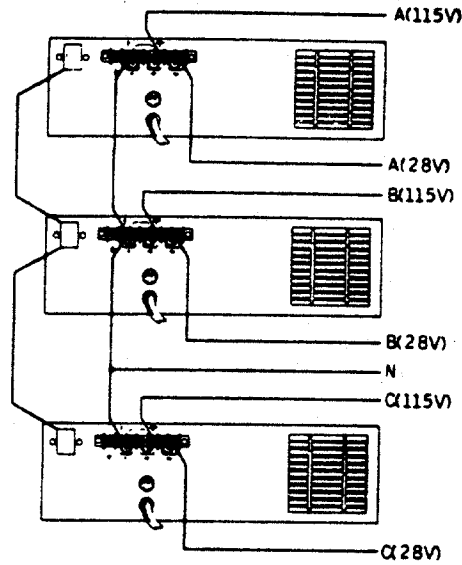

3-PHASE OPEN-DELTA (28V)

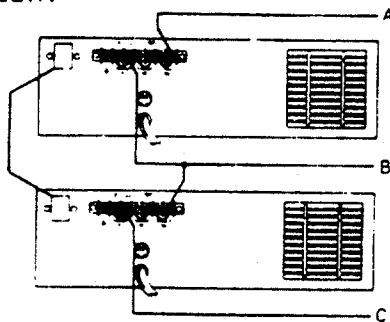

Figure 3-3. Rear Panel Connections for Two- or Three-Phase Operation

SECTION IV MAINTENANCE

4.1. SERVICE INFORMATION

4-2. Questions concerned with the operation, repair, or servicing of this instrument should be directed to the Elgar Repair Department, Elgar, 9250 Brown Deer Road, San Diego, CA 92121-2294. Include the model number and serial number in any correspondence concerning the instrument.

4.3. FACTORY REPAIR

4-4. Should it be necessary to return an instrument to the factory for repair, please contact the Elgar Repair Department for authorization to make shipment. **DO NOT RETURN THE UNIT FOR REPAIR WITHOUT AUTHORIZATION.**

4.5. SHIPPING DAMAGE

4-6. It is possible for equipment to be damaged in shipment. Therefore, it is imperative that the instrument be tested and inspected as soon as it is received. If the instrument shows signs of damage, notify the carrier immediately. The carrier's claim agent will prepare a report of damage to be forwarded to the Elgar Repair Department. You will be advised as to the action necessary to have the instrument repaired or replaced.

4.7. FREQUENCY CALIBRATION – DECADE DIAL OSCILLATORS

4-8. The X10 frequency range in the decade dial oscillators is adjusted by trimmer capacitors C112

and C120. If the 1000-10990 Hz range appears out of calibration, the capacitors should be adjusted equally until the frequency is within specification.

NOTE

Place vernier dial in CAL position when monitoring output frequency or making calibration adjustments.

4-9. The X1 frequency range is calibrated by selection of the values of trim capacitors C110 and C118. If the 100 to 1099 Hz range appears out of calibration, the value of the capacitors must be changed until the frequency is within specification.

4-10. The frequency of the X1/10 range is determined by capacitors C105, C106, C113, and C114. These are precision capacitors which ordinarily do not require adjustment. If the X1/10 frequency range appears out of calibration, these capacitors must be replaced or the unit returned to the factory for calibration.

4.11. FREQUENCY CALIBRATION – CONTINUOUSLY-VARIABLE OSCILLATOR

4-12. To calibrate the continuously-variable oscillator, loosen the clamp screws holding the body of the vernier potentiometer. Turn the body of the potentiometer until the output frequency corresponds to the dial indication, then re-tighten the clamp screws.

4-13. In two-band oscillators, the low-frequency band is calibrated by turning the body of the potentiometer. If the high frequency band is then out of

calibration, it is adjusted by selection of the values of trim capacitors C108 and C113.

4-14. If the oscillator is calibrated at a frequency near the center of its frequency band, the calibration should be within tolerance over the entire bandwidth.

4-15. PHASE ANGLE CALIBRATION

4-16. In two- and three-phase oscillators, the phase angle of the B- and C-phase signals relative to the A-phase signal is calibrated by selection of the value of trim capacitors. An accurate phase angle meter should be used to determine the phase angle calibration. The phase angles of the oscillator signals may be measured, but it is preferable to measure the phase angles at the output of the associated power sources, since this calibrates out any incidental phase shift in the power sources themselves. The capacitors to be adjusted are:

DECADE DIAL OSCILLATORS

	B \emptyset	C \emptyset
X 1/10 range	C122	C128
X 1 range	C124	C130
X 10 range	C126	C132

NARROW RANGE OSCILLATORS

Single Band	C114	C118
Dual Band — LO range	C114	C118
HI range	C117	C121

4-17. AMPLITUDE CALIBRATION

4-18. R114 is an adjustment to limit the maximum output of the oscillator to prevent overdriving the associated AC power source. To adjust, advance the front panel AMPLITUDE control of the power source fully clockwise and adjust R114 for the desired maximum output voltage. With the decade oscillators, this adjustment should be made at 45 Hz and rechecked at 5 or 10 kHz.

4-19. SIGNAL TRACING

4-20. Since the oscillator circuit is a closed loop, if a defective component interrupts the signal path, there will be no signal anywhere in the loop. To locate the defective component, if it cannot be found by normal DC measurements, inject a signal through a resistor to pin 3 of Z103. Typically, inject a 3 VRMS signal through a 3.3K resistor, using a signal of the same frequency as that for which the oscillator is set. This signal will propagate through the loop until it reaches the defective component, which can be located by tracing the signal.

4-21. CIRCUIT BOARD COMPONENT LOCATION

4-22. Component location diagrams are given for Model 403V (Figure 4-1), Decade Switch Assembly (Figure 4-2), and Model 4641V (Figure 4-3). These diagrams may be used for other oscillator models as well, considering only that certain components are omitted in the other models, as indicated on the schematic diagram.

TEST EQUIPMENT REQUIRED (or equivalent)

Distortion Analyzer	Hewlett Packard 333A
Differential Voltmeter	Fluke 931B
Digital Voltmeter	Fluke 8000A
Phase Meter	Dytronics 224
Frequency Meter	Dana 8100
Variable Capacitor substitution box	

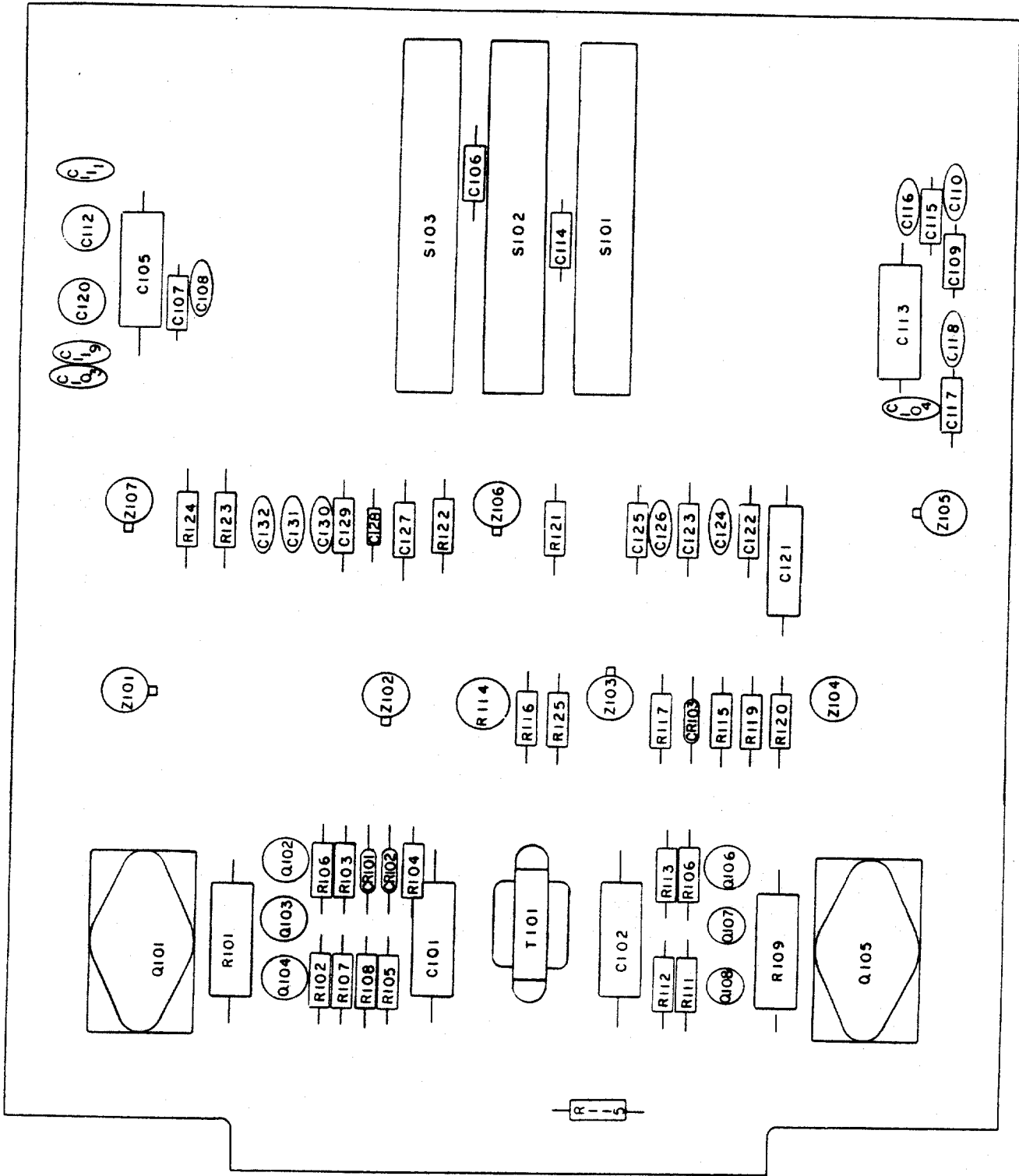

Figure 4-1. Component Location for Model 403V

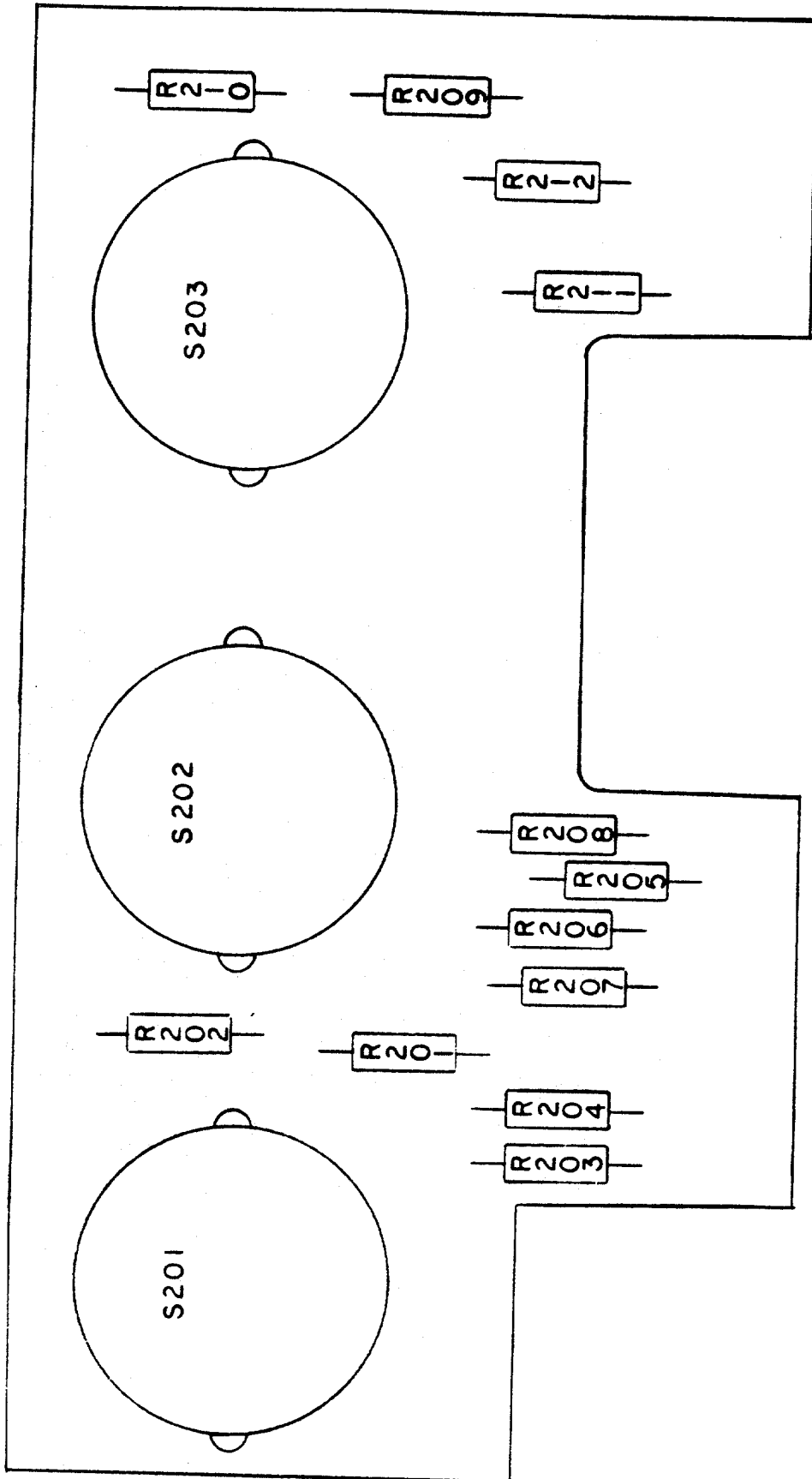

Figure 4-2. Component Location Diagram for Decade Switch Assembly

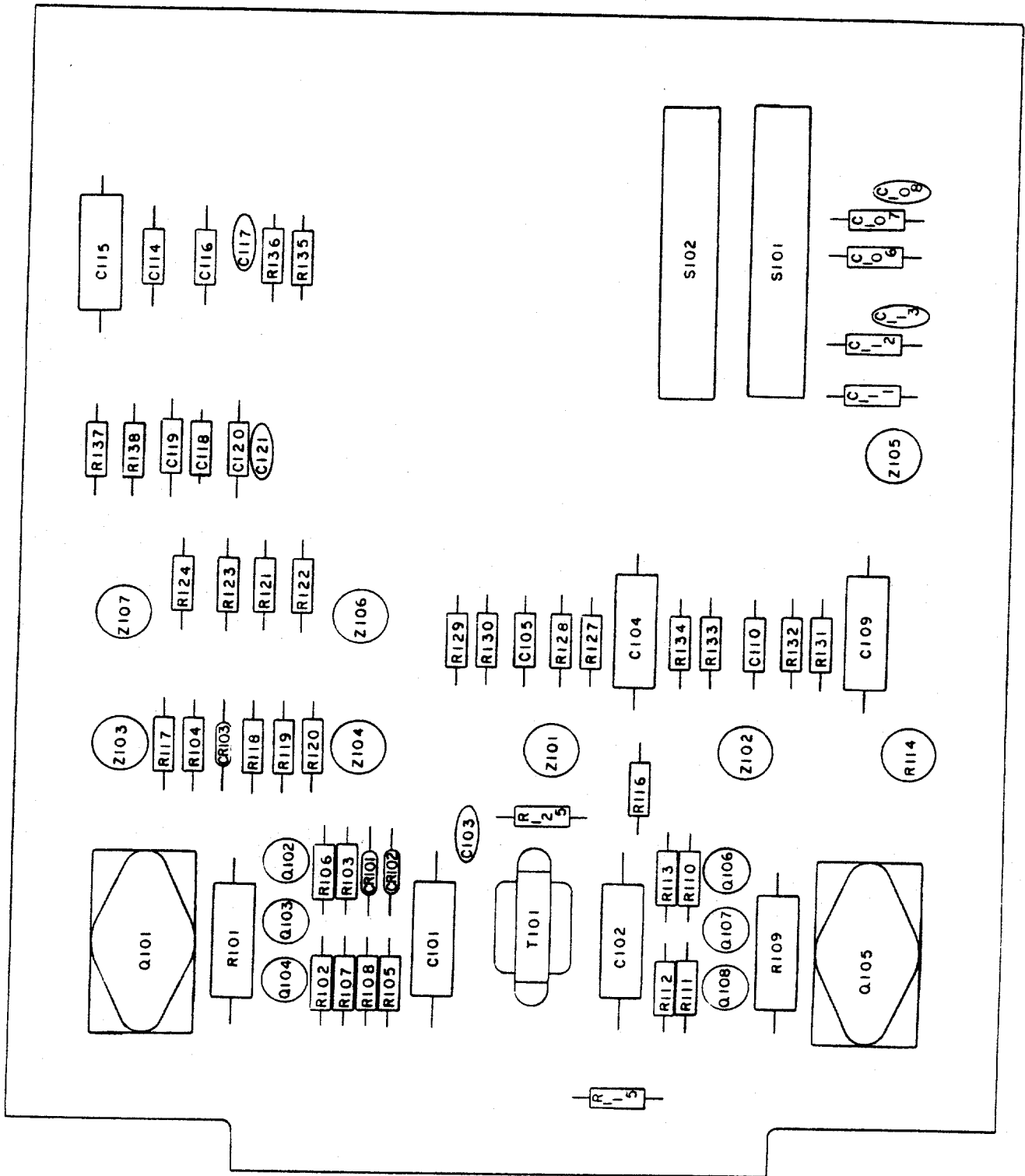

Figure 4-3. Component Location Diagram for Model 4641V

SECTION V DIAGRAMS



5-1. GENERAL

5-2. This section contains the schematic diagrams for the Series 400V Plug-in Oscillators. The schematic diagrams should be used to understand the theory of operation and as an aid in troubleshooting the unit. Reference designators shown on schematics correspond to reference designators shown in parts lists where exact component values are given.

5-3. DIAGRAMS

5-4. Diagrams included in this section are as follows:

- a. Schematic Diagram for Decade Dial Oscillators
- b. Schematic Diagram for Single Band Continuously Variable Oscillators
- c. Schematic Diagram for Dual Band Continuously Variable Oscillators

5-6. The schematics included in this section use  to indicate P2 and  to indicate pins related to Connector J1. J2 is located on the rear panel of the AC Power Source and P2 is the pins of the oscillator board which plug into Receptacle Connector J1 of the AC Power Source.

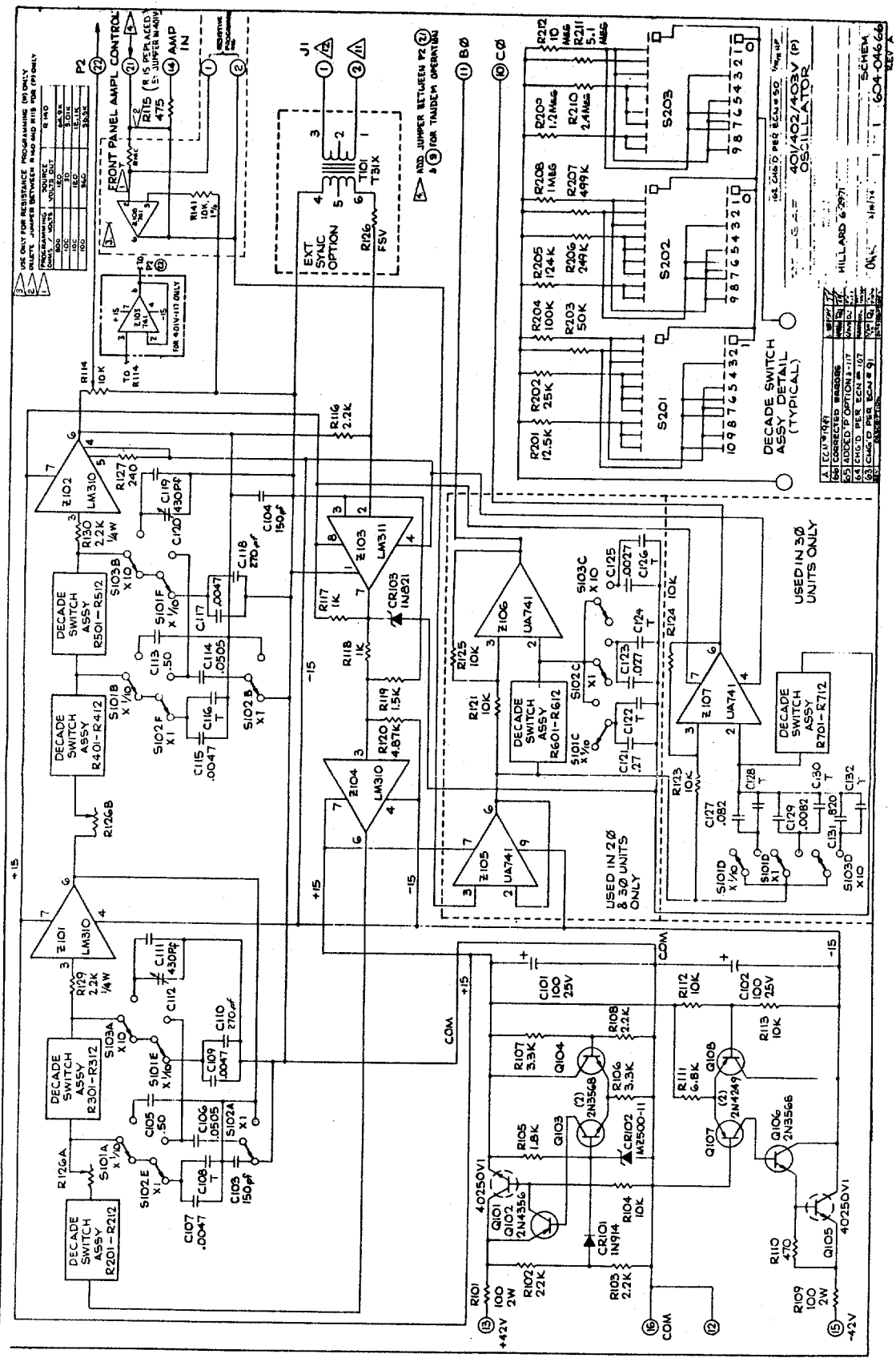

Figure 5-1. Schematic Diagram for Decade Dial Oscillators

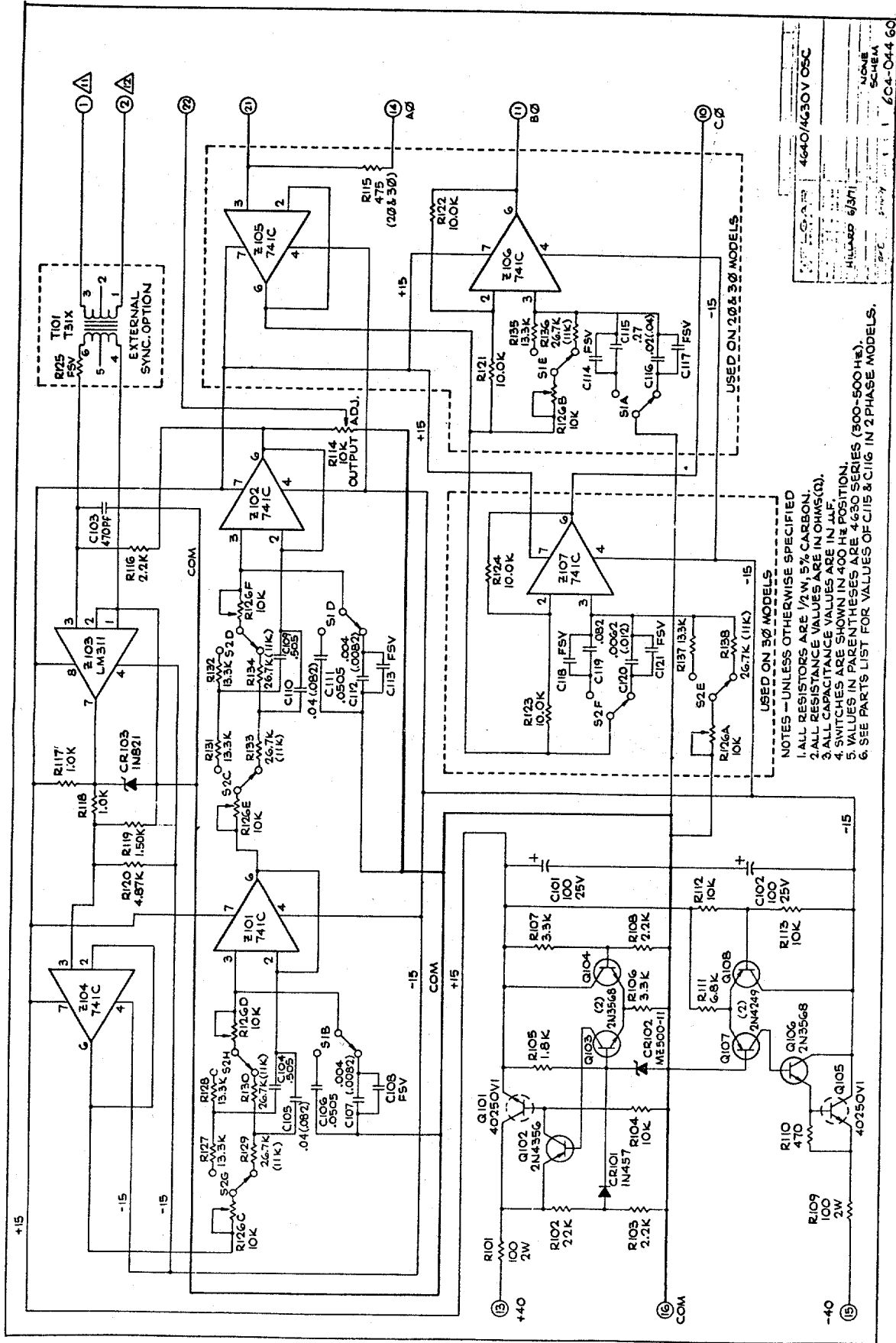

Figure 5-3. Schematic Diagram for Dual-Band Continuously Variable Oscillators

**SECTION VI
REPAIR PARTS LIST**

6-1. GENERAL

6-2. This section contains a listing of all parts necessary for factory authorized repair of the unit. Parts are located on the diagrams in Section V and correlated on the parts list by using their reference designators.

6-3 SPARE PARTS ORDERING

6-4. When ordering spare parts, specify part name, part number, manufacturer, component value and rating. If complete assemblies are desired, contact:

Elgar
9250 Brown Deer Road
San Diego, CA 92121-2294

Specify assembly number, instrument series number and instrument name when ordering.

DECADE DIAL OSCILLATORS

SCHEMATIC DESIGNATION	VALUE	DESCRIPTION OR TYPE	RATING	MANUFACTURER		ELGAR PART NUMBER
				NAME	PART NUMBER	
PARTS USED ON ALL MODELS						
R101,109	100 ohm	Resistor	2W, 5%	Speer	RC42GF101J	804-101-05
R102	22K	Resistor	½W, 5%	Speer	RC20GF223J	802-223-05
R103,108,116	2.2K	Resistor	½W, 5%	Speer	RC20GF222J	802-222-05
R104,112,113	10K	Resistor	½W, 5%	Speer	RC20GF103J	802-103-05
R105	1.8K	Resistor	½W, 5%	Speer	RC20GF182J	802-182-05
R106,107	3.3K	Resistor	½W, 5%	Speer	RC20GF332J	802-332-05
R110	470	Resistor	½W, 5%	Speer	RC20GF471J	802-471-05
R111	6.8K	Resistor	½W, 5%	Speer	RC20GF682J	802-682-05
R114	10K	Resistor	½W, 5%	Speer	63P103	819-103-84
R115	475	Potentiometer		Spectrol		
R117,118	1K	Resistor	1/8W, 1%	Dale	RN60C4750F	813-475-0F
R119	1.5K	Resistor	1/8W, 1%	Dale	RN60C1001F	813-100-1F
R120	4.87K	Resistor	1/8W, 1%	Dale	RN60C1501F	813-150-1F
R126	500-500	Resistor	1/8W, 1%	Dale	RN60C4871F	813-487-1F
R127	240	Potentiometer		Allen-Bradley	70C1G040S501U	819-501-70
R129,130	22K	Resistor	½W, 5%	Speer	RC20GF244J	802-244-05
C101,102	100 uF	Resistor	½W, 5%	Speer	RC07GF223J	801-223-05
C103,104	150 pF	Capacitor	25V	Sprague	500D107G025DD7	824-107-51
C105,113	.50	Capacitor	500V, 5%	Arco	DM15-151J	820-151-05
C106,114	.0505	Capacitor	100, 1%	IMB	BA1B504F	822-504-11
C107,109,115,117	.0047	Capacitor	100V, 1%	IMB	BA1B5052F	829-505-2F
C108,116	FSV	Capacitor	100V, 1%	IMB	BA1B472F	822-472-11
C110,118	270 pF	Capacitor	500V, 5%	Centralab	DM15-271J	820-271-05
C111,119	430 pF	Capacitor	500V, 5%		DM19-431	820-431-05
C112,120	15-60 pF	Capacitor		Erie	538-011F	828-015-60
CR101		Diode		TI	1N914	844-914-XX
CR102		Zener Diode		Motorola	MZ500-11	843-500-11
CR103		Zener Diode		Dixon	1N821	843-821-XX
O101,105		Transistor		RCA	40250V1	839-402-5V
O102		Transistor		Fairchild	2N4356	834-435-6X
O103,104,106		Transistor		Fairchild	2N3568	835-356-8X
O107,108		Transistor		Fairchild	2N4249	832-424-9X
S101,102,103		Switch		Centralab	PB15-8-1L-BL	860-P15-1L

DECADE DIAL OSCILLATORS (Continued)

SCHEMATIC DESIGNATION	VALUE	DESCRIPTION OR TYPE	RATING	MANUFACTURER		ELGAR PART NUMBER
				NAME	PART NUMBER	
Z101,102,104 Z103		Volt. Follower Volt. Comparator		National National	LM310 LM311	849-LM3-10 849-LM3-11
ADDITIONAL PARTS USED ON MODEL 402V						
R121,125 C121	10K .27 uF	Resistor Capacitor	1/8W, 1% 100V, 1%	Dale IMB	RN60C1002F BA1B274F	813-100-2F 822-274-11
C122,124,126 C123	FSV .027 uF	Capacitor Capacitor	100V, 1% 100V, 1%	IMB IMB	BA1B273F BA1B272F	822-273-11 822-272-11
C125 Z105,106	.0027 uF	Op Amp		Motorola	1741CG	849-174-1X
ADDITIONAL PARTS USED ON MODEL 403V						
R123,124 C127	10K .082 uF	Resistor Capacitor	1/8W, 1% 100V, 1%	Dale IMB	RN60C1002F BA1B823F	813-100-2F 822-823-11
C128,130,132 C129	FSV .0082 uF	Capacitor Capacitor	100V, 1% 500V, 5%	IMB Arco	BA1B822 DM15-821J	822-822-11 820-821-05
C131 Z107	820 pF	Op Amp		Motorola	1741CG	849-174-1X
DECADE DIAL OSCILLATORS SWITCH BOARD ASSEMBLY						
Model 401 requires 4 pieces — Model 402V requires 5 pieces — Model 403V requires 6 pieces						
R201	12.5K	Resistor	1/8W, 1/4%	Dale	RN60C1251C	814-125-2C
R202	25K	Resistor	1/8W, 1/4%	Dale	RN60C2502C	814-250-2C
R203	50K	Resistor	1/8W, 1/4%	Dale	RN60C5002C	814-500-2C
R204	100K	Resistor	1/8W, 1/4%	Dale	RN60C1003C	814-100-3C
R205	124K	Resistor	1/4W, 1%	Dale	RN60D1243F	815-124-3F
R206	249K	Resistor	1/4W, 1%	Dale	RN60D2493F	815-249-3F
R207	499K	Resistor	1/4W, 1%	Dale	RN60D4993F	815-499-3F
R208	1M	Resistor	1/4W, 1%	Dale	RN60D1004F	815-100-4F
R209	1.2M	Resistor	1/2W, 5%	Speer	RC20GF125J	802-125-05
R210	2.4M	Resistor	1/2W, 5%	Speer	RC20GF245J	802-245-05
R211	5.1M	Resistor	1/2W, 5%	Speer	RC20GF515J	802-515-05
R212	10M	Resistor	1/2W, 5%	Speer	RC20GF106J	802-106-05

CONTINUOUSLY VARIABLE OSCILLATORS

SCHEMATIC DESIGNATION	VALUE	DESCRIPTION OR TYPE	RATING	MANUFACTURER		ELGAR PART NUMBER
				NAME	PART NUMBER	
R101,109	100 ohm	Resistor	2W, 5%	Speer	RC42GF101J	804-101-05
R102	22K	Resistor	½W, 5%	Speer	RC20GF223J	802-223-05
R103,108,116	2.2K	Resistor	½W, 5%	Speer	RC20GF222J	802-222-05
R104,112,113	10K	Resistor	½W, 5%	Speer	RC20GF103J	802-103-05
R105	1.8K	Resistor	½W, 5%	Speer	RC20GF182J	802-182-05
R106,107	3.3K	Resistor	½W, 5%	Speer	RC20GF332J	802-332-05
R110	470 ohm	Resistor	½W, 5%	Speer	RC20GF472J	802-471-05
R111	6.8K	Resistor	½W, 5%	Speer	RC20GF682J	802-682-05
R114	10K	Potentiometer		Spectrol	84-3-8-103	819-103-84
R117,118	1.0K	Resistor	1/8W, 1%	Dale	RN60C1001F	813-100-1F
R119	1.5K	Resistor	1/8W, 1%	Dale	RN60C1501F	813-150-1F
R120	4.87K	Resistor	1/8W, 1%	Dale	RN60C4871F	813-487-1F
C101,102	100 uF	Capacitor	25V	Sprague	500D107G025DD7	824-107-51
C103	470 pF	Capacitor	500V, 5%	Arco	DM15-471J	820-471-05
CR101		Diode		Fairchild	1N457	844-457-XX
CR102		Zener Diode	6.2V	Motorola	MZ500-11	843-500-11
CR103		Zener Diode		Dixon	1N821	843-821-XX
Q101,105		Transistor		RCA	40250V1	839-402-5X
Q102		Transistor		Fairchild	2N4356	834-435-6X
Q103,104,106		Transistor		Fairchild	2N3568	835-356-8X
Q107,108		Transistor		Fairchild	2N4249	832-424-9X
Z101,102,104		Op Amp		Motorola	1741CG	849-174-1X
Z103		Volt. Comparator		National	LM311	849-LM3-11
ADDITIONAL PARTS USED ON ALL SINGLE-PHASE MODELS						
R126	10K	4 Gang Pot		Elgar		819-103-X4
ADDITIONAL PARTS USED ON SINGLE-BAND MODEL 461V						
R127,128,131,132	13.3K	Resistor	1/8W, 1%	Dale	RN60C1332F	813-133-2F
C104,109	.505 uF	Capacitor	100V, 1%	IMB	BA1B5053F	829-505-3F
C106,111	.0505 uF	Capacitor	100V, 1%	IMB	BA1B5052F	829-505-2F

CONTINUOUSLY VARIABLE OSCILLATORS (Continued)

SCHEMATIC DESIGNATION	VALUE	DESCRIPTION OR TYPE	RATING	MANUFACTURER		ELGAR PART NUMBER
				NAME	PART NUMBER	
ADDITIONAL PARTS USED ON SINGLE-BAND MODEL 441V						
R127,128,131,132	26.7K	Resistor	1/8W, 1%	Dale	RN60C2672F	813-267-2F
C104,109	.04 uF	Capacitor	100V, 1%	IMB	BA1B403F	822-403-11
C106,111	.004 uF	Capacitor	100V, 1%	IMB	BA1B402F	822-402-11
ADDITIONAL PARTS USED ON SINGLE-BAND MODEL 431V						
R127,128,131,132	11K	Resistor	1/8W, 1%	Dale	RN60C1102F	813-110-2F
C104,109	.082 uF	Capacitor	100V, 1%	IMB	BA1B823F	822-823-11
C106,111	.0082 uF	Capacitor	100V, 1%	IMB	BA1B822F	822-822-11
ADDITIONAL PARTS USED ON TWO-PHASE MODELS						
R115	475 ohm	Resistor	1/8W, 1%	Dale	RN60C4750F	813-475-0F
R121,122	10K	Resistor	1/8W, 1%	Dale	RN60C1002F	813-100-2F
R126	10K	5 Gang Pot		Elgar		819-103-X5
Z105,106		Op Amp		Motorola	1741CG	849-174-1X
ADDITIONAL PARTS USED ON TWO-PHASE MODEL 462V						
R135	13.3K	Resistor	1/8W, 1%	Dale	RN60C1332F	813-133-2F
C114	FSV	Capacitor	100V, 1%	IMB	BA1B274F	822-274-11
C115	.27 uF	Capacitor				
ADDITIONAL PARTS USED ON TWO-PHASE MODEL 442V						
R135	26.7K	Resistor	1/8W, 1%	Dale	RN60C2672F	813-267-2F
C114	FSV	Capacitor	100V, 1%	IMB	BA1B203F	822-203-11
C115	.02 uF	Capacitor				
ADDITIONAL PARTS USED ON TWO-PHASE MODEL 432V						
R135	11K	Resistor	1/8W, 1%	Dale	RN60C1102F	813-110-2F
C114	FSV	Capacitor	100V, 1%	IMB	BA1B403F	822-403-11
C115	.04 uF	Capacitor				

CONTINUOUSLY VARIABLE OSCILLATORS (Continued)

SCHEMATIC DESIGNATION	VALUE	DESCRIPTION OR TYPE	RATING	MANUFACTURER		ELGAR PART NUMBER
				NAME	PART NUMBER	
ADDITIONAL PARTS USED ON ALL THREE-PHASE MODELS						
R123,124	10K	Resistor 6 Gang Pot Op Amp	1/8W, 1%	Dale Elgar Motorola	RN60C1002F 1741CG	813-100-2F 819-103-X6 849-174-1X
R126	10K					
Z107						
ADDITIONAL PARTS USED ON THREE-PHASE MODEL 463V						
R135	13.3K	Resistor	1/8W, 1%	Dale	RN60C1332F	813-133-2F
C114	FSV	Capacitor	100V, 1%	IMB	BA1B823F	822-823-11
C115	.082 uF					
ADDITIONAL PARTS USED ON THREE-PHASE MODEL 443V						
R137	26.7K	Resistor	1/8W, 1%	Dale	RN60C2672F	813-267-2F
C118	FSV	Capacitor	100V, 1%	IMB	BA1B622F	822-622-11
C119	.0062 uF					
ADDITIONAL PARTS USED ON THREE-PHASE MODEL 433V						
R137	11K	Resistor	1/8W, 1%	Dale	RN60C1102F	813-110-2F
C118	FSV	Capacitor	100V, 1%	IMB	BA1B123F	822-123-11
C119	.012 uF					
ADDITIONAL PARTS USED ON DUAL-BAND MODEL 4641V						
R127,128,131,132	13.3K	Resistor	1/8W, 1%	Dale	RN60C1332F	813-133-2F
R129,130,133,134	26.7K	Resistor	1/8W, 1%	Dale	RN60C2672F	813-267-2F
C104,109	.505 uF	Capacitor	100V, 1%	IMB	BA1B5053F	829-505-3F
C105,110	.04 uF	Capacitor	100V, 1%	IMB	BA1B403F	822-403-11
C106,111	.0505 uF	Capacitor	100V, 1%	IMB	BA1B5052F	829-505-2F
C107,112	.004 uF	Capacitor	100V, 1%	IMB	BA1B402F	822-402-11
C108,113		Capacitor	100V, 1%	IMB		

CONTINUOUSLY VARIABLE OSCILLATORS (Continued)

SCHEMATIC DESIGNATION	VALUE	DESCRIPTION OR TYPE	RATING	MANUFACTURER		ELGAR PART NUMBER
				NAME	PART NUMBER	
ADDITIONAL PARTS USED ON DUAL-BAND MODEL 4631V						
R127,128,131,132	13.3K	Resistor	1/8W, 1%	Dale	RN60C1332F	813-133-2F
R129,130,133,134	11K	Resistor	1/8W, 1%	Dale	RN60C1102F	813-110-2F
C104,109	.505 uF	Capacitor	100V, 1%	IMB	BA1B5053F	829-505-3F
C105,110	.082 uF	Capacitor	100V, 1%	IMB	BA1B823F	822-283-11
C106,111	.0505 uF	Capacitor	100V, 1%	IMB	BA1B5052F	829-505-2F
C107,112	.0082 uF	Capacitor	100V, 1%	IMB	BA1B822F	822-822-11
C108,113	FSV	Capacitor	100V, 1%	IMB		
ADDITIONAL PARTS USED ON ALL DUAL-BAND, TWO-PHASE MODELS						
R115	475 ohm	Resistor	1/8W, 1%	Dale	RN60C4750F	813-475-0F
R121,122	10K	Resistor	1/8W, 1%	Dale	RN60C1002F	813-100-2F
R126	10K	5 Gang Pot		Elgar		819-103-X5
Z105,106		Op Amp		Motorola	1741CG	849-174-1X
ADDITIONAL PARTS USED ON DUAL-BAND, TWO-PHASE MODEL 4642V						
R135	13.3K	Resistor	1/8W, 1%	Dale	RN60C1332F	813-133-2F
R136	26.7K	Resistor	1/8W, 1%	Dale	RN60C2672F	813-267-2F
C114,117	FSV	Capacitor	100V, 1%	IMB	BA1B274F	822-274-11
C115	.27 uF	Capacitor	100V, 1%	IMB	BA1B203F	822-203-11
C116	.02 uF	Capacitor	100V, 1%	IMB		
ADDITIONAL PARTS USED ON DUAL-BAND, TWO-PHASE MODEL 4632V						
R135	13.3K	Resistor	1/8W, 1%	Dale	RN60C1332F	813-133-2F
R136	11K	Resistor	1/8W, 1%	Dale	RN60C1102F	813-110-2F
C114,117	FSV	Capacitor	100V, 1%	IMB	BA1B274F	822-274-11
C115	.27 uF	Capacitor	100V, 1%	IMB	BA1B403F	822-403-11
C116	.04 uF	Capacitor	100V, 1%	IMB		

CONTINUOUSLY VARIABLE OSCILLATORS (Continued)

SCHEMATIC DESIGNATION	VALUE	DESCRIPTION OR TYPE	RATING	MANUFACTURER		ELGAR PART NUMBER
				NAME	PART NUMBER	
ADDITIONAL PARTS USED ON ALL DUAL-BAND, THREE-PHASE MODELS						
R123,124	10K	Resistor	1/8W, 1%	Dale	RN60C1002F	813-100-2F
R126	10K	6 Gang Pot		Elgar		819-103-X6
Z107		Op Amp		Motorola	1741CG	849-174-1X
ADDITIONAL PARTS USED ON DUAL-BAND, THREE-PHASE MODEL 4643V						
R137	13.3K	Resistor	1/8W, 1%	Dale	RN60C1332F	813-133-2F
R138	26.7K	Resistor	1/8W, 1%	Dale	RN60C2672F	813-267-2F
C118,121	FSV	Capacitor	100V, 1%	IMB	BA1B823F	822-823-11
C119	.082 uF	Capacitor	100V, 1%	IMB	BA1B622F	822-622-11
ADDITIONAL PARTS USED ON DUAL-BAND, THREE-PHASE MODEL 4633V						
R137	13.3K	Resistor	1/8W, 1%	Dale	RN60C1332F	813-133-2F
R138	11K	Resistor	1/8W, 1%	Dale	RN60C1102F	813-110-2F
C118,121	FSV	Capacitor	100V, 1%	IMB	BA1B823F	822-823-11
C119	.082 uF	Capacitor	100V, 1%	IMB	BA1B123F	822-123-11
EXTERNAL SYNC OPTION ON ANY MODEL						
R125	FSV	Transformer		Triad	T31X	850-T31-XX
T101						