

This literature was published years prior to the establishment of Agilent Technologies as a company independent from Hewlett-Packard and describes products or services now available through Agilent. It may also refer to products/services no longer supported by Agilent. We regret any inconvenience caused by obsolete information. For the latest information on Agilent's test and measurement products go to:

www.agilent.com/find/products

Or in the US, call Agilent Technologies at 1-800-452-4844 (8am-8pm EST)

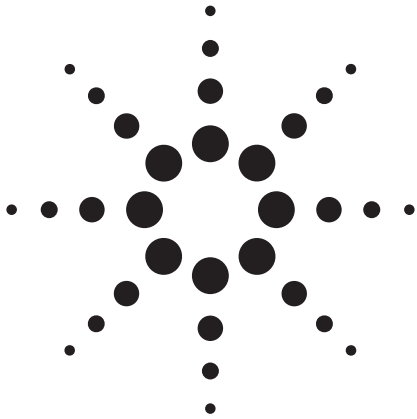

Agilent **70340A Modular Signal Generator** 1 to 20 GHz

70341A Frequency Extension Module 0.01 to 1.0 GHz

The high performance
signal generator for
modular test systems

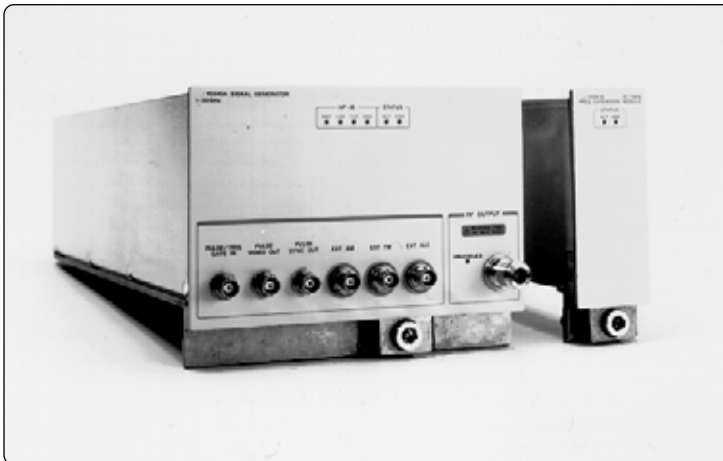

All the Performance of Rack-and-Stack Signal Sources in Half the Space

Unlock the Power of Modular ATE

The HP 70340A is the first signal generator that delivers the performance, flexibility and value only modular ATE can provide. Designed to meet the need for a downsized, high performance signal source, the HP 70340A blends state-of-the-art

technologies in a new microwave signal generator design to achieve unprecedented performance and value. The HP 70340A's combination of high output power, excellent spectral purity, powerful modulation, small size and light weight is unmatched by any other signal generator.

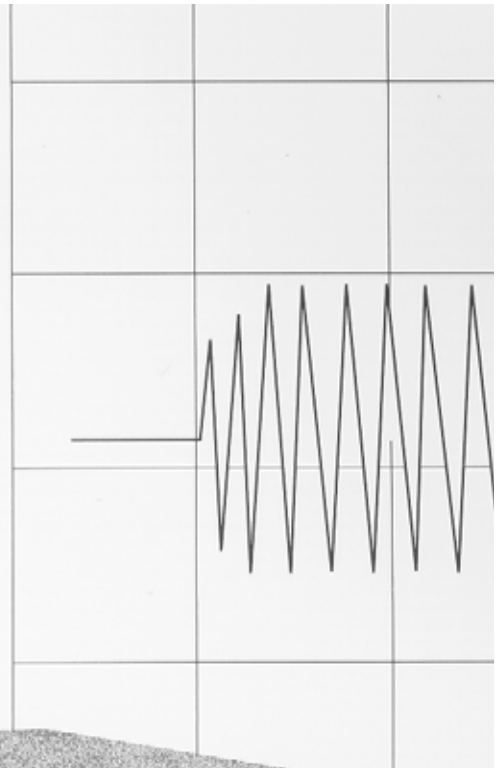

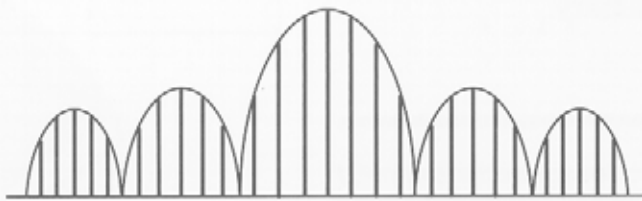

Flexible frequency coverage matches performance to your application

- HP 70340A provides complete, broadband 1 to 20 GHz coverage in a single module.
- HP 70341A Frequency Extension Module expands coverage down to 10 MHz.
- HP 70340A and HP 70341A combination provides 10 MHz to 20 GHz through a single RF output connector.
- 1 kHz frequency resolution standard; 1 Hz optional.

Unsurpassed output level accuracy and flatness generates measurement precision

- ± 1 dB internal level accuracy
- ± 0.5 dB internal flatness
- 0.01 dB output level resolution
- User Level Correction allows transfer of power meter accuracy to signal generator output at any remote point.

Excellent spectral purity provides "single-signal" accuracy and maximum dynamic range

- Exceptionally low harmonics in all modes of operation (typically < -60 dBc).
- Fundamental microwave oscillators eliminate sub-harmonic signals.
- Low SSB phase noise (typically < -95 dBc/Hz at 10 kHz offset at $f_c = 6$ GHz).
- Quiet AM noise floor (typically < -150 dBm/Hz).

Full modulation capability simulates real-world signals

- Fast, accurate pulse modulation:
 - < 10 nanosecond rise/fall times
 - > 80 dB on/off ratio
- Multi-mode internal pulse modulation source (optional)
- Wideband, high index FM:
 - > 10 MHz peak deviation
 - > 1 MHz maximum rate
 - Modulation index > 300
- Log AM for antenna scan simulation and power sweeps:
 - > 60 dBc depth
 - Fast step response (typically < 5 microseconds)
- Excellent AM accuracy and linearity
- Simultaneous AM, FM and pulse modulation.

Industry standard, open architecture reduces risk

- Modular platform simplifies system upgrades.
- Designed in the Modular Measurement System (MMS) for maximum performance.

Versatile programming speeds system integration

- Standard commands for programmable instrumentation (SCPI) programming protects software investment.
- Optional CIIL capability meets MATE requirements.

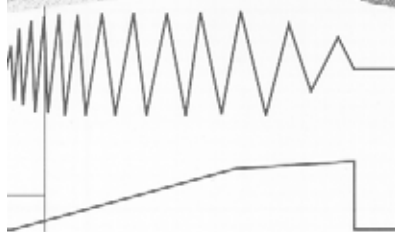
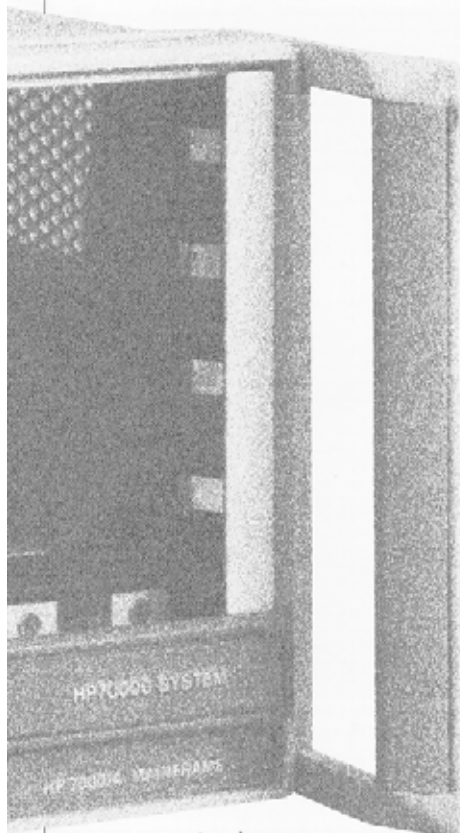

Performance and Flexibility to Satisfy Your Application.

Signal simulation and receiver test

Simulate "real world" signals with the powerful modulation capability of the HP 70340A. Combine the high performance AM, FM and pulse modulations to generate the complex signals required for evaluating sophisticated receivers and sub-systems. Broad frequency coverage, excellent spectral purity and plenty of output power provide the flexibility necessary to evaluate modern receiver performance. Half rack width size makes the HP 70340A an excellent choice in multiple source applications including intermodulation testing and multi-emitter EW simulation.

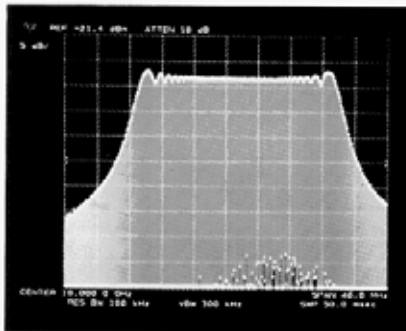

The HP 70340A's high index FM simplifies simulation of frequency chirped and telemetry signals.

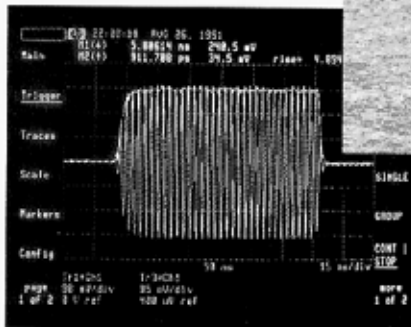

Compact component test system

The HP 70340A is a natural companion signal source for the HP 71500A Microwave Transition Analyzer. Together these two modular instruments offer powerful pulsed component test capability in a small, easy to configure system ideal for production test stations as well as R&D. Test components to their limits with the fast, clean pulse modulation of the HP 70340A. Excellent pulse flatness, low overshoot and minimum video feedthrough improve accuracy in pulsed component measurements. Optional 1 Hz frequency resolution provides full system capability.

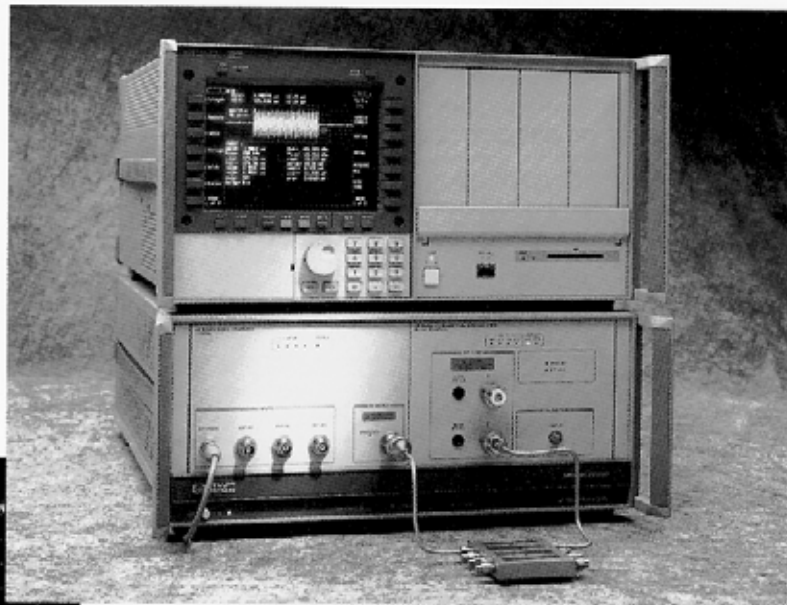

Excellent pulse fidelity makes the HP 70340A an ideal pulsed component and EW receiver stimulus.

SIGNAL SIMULATION
& RECEIVER TEST

COMPONENT TEST

COMMUNICATIONS

FIELD & DEPOT ATE

BENCHTOP

Clean clock source for high speed bit error rate testing

Low noise signals with minimum jitter are critical for accurate BER and C/N testing. Low phase noise and spurious, 1 Hz frequency resolution and high output power make the HP 70340A an excellent clock source for the HP 71600 series of high speed digital testers. Combine the HP 70340A with these and other modular test instruments to provide a complete, high performance satellite, lightwave or LAN-based communications test station.

Match performance to mission in tomorrow's field portable ATE

Small size, low weight and proven MMS ruggedness make the HP 70340A the signal source of choice in tomorrow's portable ATE. Whether you're testing on the flightline, at isolated repeater sites or on the go with van mounted ATE, the HP 70340A delivers the performance you need to meet your mission requirements.

The power of modularity is ideal for benchtop applications too!

The HP 70340A and other Hewlett-Packard modular instruments are also excellent performers in benchtop applications. Improve synchronization, eliminate clutter and increase test flexibility without losing capability. The high performance and low spurious emissions of the HP 70340A make it a perfect signal source for benchtop applications in state-of-the-art R&D, manufacturing, quality assurance and metrology.

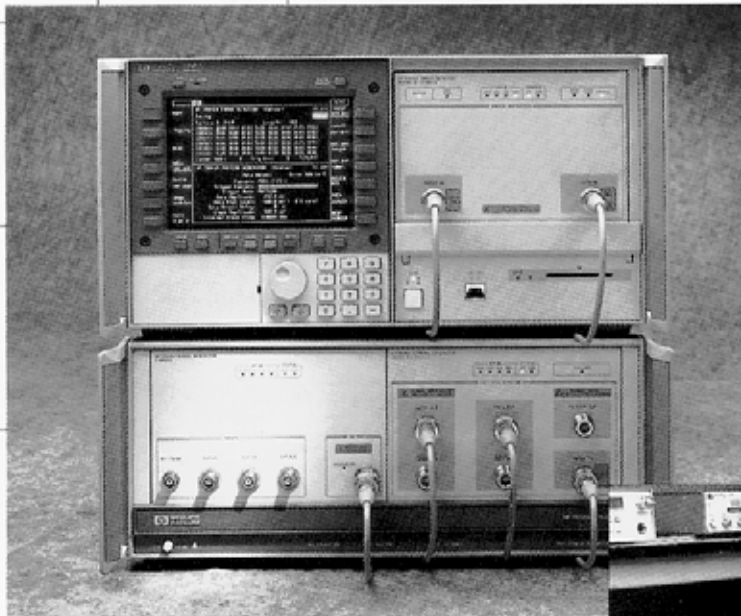

The performance and flexibility of the HP 70340A make it an ideal BERT clock source (above) as well as an excellent general purpose signal source in benchtop applications (right).



MMS Flexibility: Add Capability Only When You Need It

Extend Your Capabilities with High-Performance RF Testing

Add 10 MHz to 1 GHz frequency coverage, only when you need it. The HP 70341A Frequency Extension Module isn't what you expect. It's better. The HP 70340A's powerful modulation, low harmonics (<-55 dBc) and spurious (<-60 dBc) and zero subharmonics are available from 10 MHz to 1 GHz with higher output power (typically +20 dBm) and lower phase noise, all in a 1/8th MMS module.

Traditional synthesized signal generators use a heterodyne method followed by an amplifier to generate frequencies less than 2 GHz. Downconversion causes high spurious, while the amplifier increases broadband noise considerably. System engineers testing broadband receivers require excellent spectral purity and modulation performance across the band. The performance of traditional signal generators below 2 GHz required the acquisition of a separate RF signal generator and external modulator, increasing system size and cost.



The HP 70340/341A combination generates precision signals from HF to microwave without requiring a second generator. Digital divider technology reduces phase noise by 6 dB per octave, making the HP 70340/341A an ideal in-channel receiver test stimulus as well as a powerful microwave signal source. Elimination of the downconversion mixers also reduces broadband noise to a low -150 dBm/Hz, preventing saturation of sensitive receivers. Switched low pass filters reduce harmonics and spurious, while maintaining fast, high-fidelity pulse modulation. Logarithmic AM adds capability for simulation of EW threats below 2 GHz, a feature not found in RF signal generators. Level accuracy (± 2 dB) and flatness (± 0.5 dB) are preserved, as full 10 MHz to 20 GHz coverage is available from a single RF connector. The HP 70341A is slaved to the HP 70340A so when it's time to upgrade your test system, all the system software runs on the combination without any changes!

In only 1/8th MMS module, the HP 70341A adds superior RF signal generator performance, including full modulation capability, <-55 dBc harmonics and typical output power of +20 dBm

Specifications

SPECIFICATIONS describe the instrument's warranted performance over the 0° to 55°C temperature range unless otherwise noted. SUPPLEMENTAL CHARACTERISTICS (indicated by italics) are intended to provide information useful in estimating instrument capability in your application by describing typical, but not warranted, performance

Frequency

Range: HP 70340A Modular Signal Generator, 1.0 to 20.0 GHz

HP 70341A Frequency Extension Module, 10 MHz to 1 GHz

HP 70341A can only be used in combination with the HP 70340A.

Resolution: 1 kHz (1 Hz with Option 1E8)

Stability (with external high stability timebase):

Aging Rate: same as external reference.

Temperature Effects: same as external reference.

Stability (without external high stability timebase):

Aging Rate: $<1.0 \times 10^{-6}$ /day after 72-hours at 25°C $\pm 10^\circ\text{C}$

Temperature Effects: $<5 \times 10^{-6}$ over 0 to 55°C referenced to 25°

Frequency Switching Time: <50 ms to within 1 kHz, 1 - 20 GHz. <100 ms to within 1 kHz, 10 MHz - 1 GHz.

RF Output

Maximum Leveled Output Power:

Frequency	Standard	with Option 1E1
0.01 - 1 GHz	+13 dBm	+13 dBm
1 - 18 GHz	+11 dBm	+10 dBm
18 - 20 GHz	+10 dBm	+8 dBm

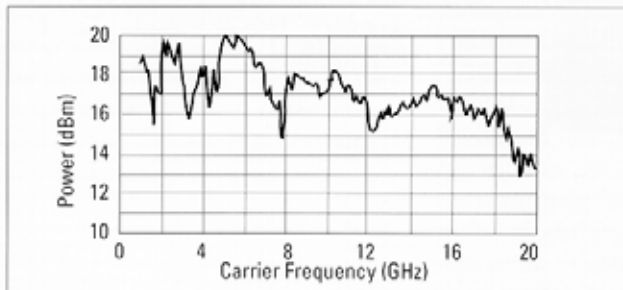

Typical maximum available output power from 1 to 20 GHz, at 25°C with output step attenuator (Option 1E1) installed.

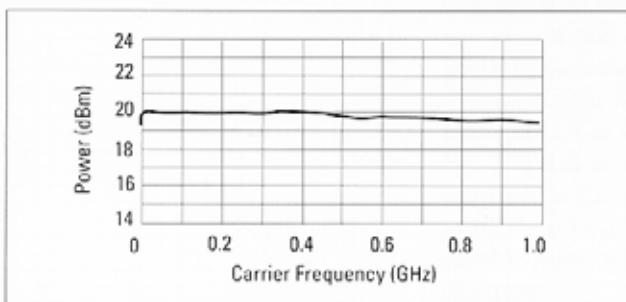

Typical maximum available output power from 0.01 to 1 GHz at 25°C.

Display Resolution: 0.01 dB

Minimum Leveled Output Power (without Option 1E1): -4 dBm.

Minimum Leveled Output Power (with Option 1E1): -90 dBm

Accuracy (-4 dBm to specified maximum leveled output power¹): ± 1.3 dB, 10 - 50 MHz. ± 1.0 dB, 50 MHz - 20 GHz.

Accuracy (over all specified temperatures and power levels¹): ± 2.3 dB, 10 - 50 MHz. ± 2.0 dB, 50 MHz - 20 GHz.

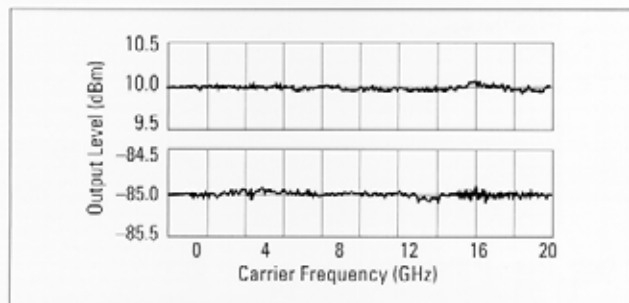

Typical output level accuracy and flatness at +10 and -85 dBm.

Flatness: ± 0.5 dB¹

Level Switching Time: <15 ms (without step attenuator range change. Attenuator range changes occur at -4 dBm, -14 dBm, -24 dBm, etc.)

Output SWR: $<2.0 : 1$ nominal

¹The use of Type-N RF connectors above 18.0 GHz degrades specification typically by 0.2 dB.

Spectral Purity

SSB Phase Noise (dBc/Hz):

Carrier Freq.	Offsets			
	100 Hz	1 kHz	10 kHz	100 kHz
500 MHz	-70	-86	-103	-119
2 GHz	-66	-74	-91	-107
10 GHz	-69	-75	-79	-101
18 GHz	-63	-70	-73	-99

Phase noise decreases 6 dB/octave below 500 MHz and reaches a floor of <-140 dBc/Hz.

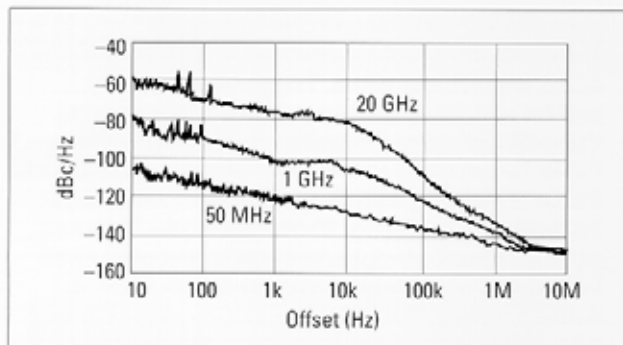

Typical single-sideband phase noise at 50 MHz, 1 GHz and 20 GHz, 25°C, CW mode. Offsets less than 100 Hz require use of external high stability timebase.

Harmonics: <-55 dBc at output levels $<+6$ dBm, 0.01 to 20 GHz

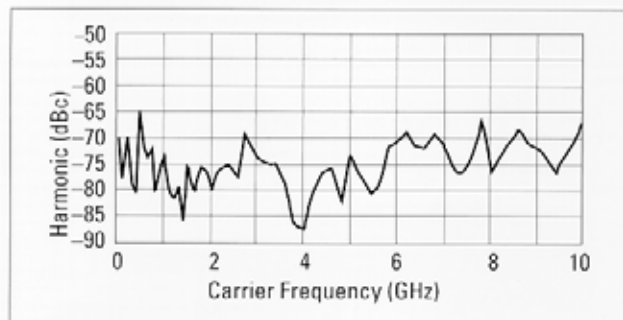

Typical 2nd harmonic levels measured at output power of +6 dBm.

Non-Harmonic Spurious (≥ 3 kHz): <-60 dBc (includes power supply and frequency synthesis spurious).

Non-Harmonic Spurious (< 3 kHz): <-50 dBc

Sub-Harmonics: None

Residual FM:

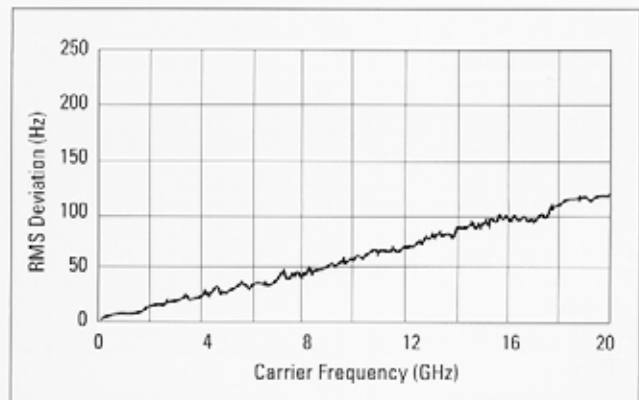

Typical residual FM measured in 50 Hz - 15 kHz bandwidth, CW mode.

At 1 GHz, <15 Hz in 50 Hz - 15 kHz bandwidth. Residual FM decreases 6 dB per octave below 1 GHz.

AM Noise Floor (at 0 dBm and offsets greater than 5 MHz from carrier): <-150 dBm/Hz, 1 - 20 GHz. <-140 dBm/Hz, 0.01 - 1 GHz.

Modulation

CARRIER FREQUENCY	<25 MHz	25 - <64 MHz	64 - <128 MHz	128 - <500 MHz	500 - <1000 MHz	1 - 20 GHz
Minimum Pulse Width	<1 μ s		<100 ns		<25 ns <i>Typically <10 ns</i>	
Rise/Fall Time	<500 ns	<350 ns	<50 ns	<35 ns	<20 ns	<10 ns
Video Feedthrough	<2 mV peak-to-peak at 0 dBm					<20 mV peak-to-peak at 0 dBm
Pulse Width Compression	± 150 ns		± 15 ns		± 5 ns	
Pulse Delay (Video out to RF out)	<1 μ sec		<200 ns		<125 ns	<100 ns

Pulse Modulation

On/Off Ratio: >80 dB

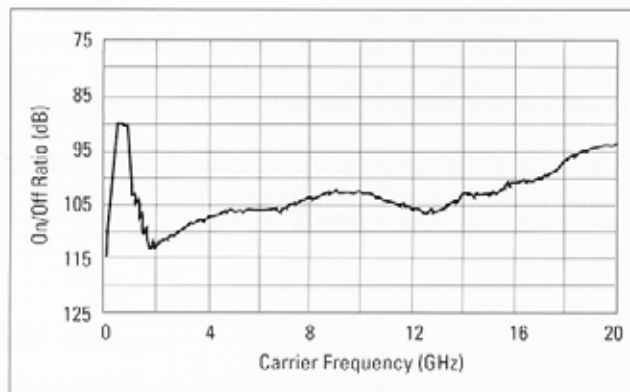

Typical pulse modulation on/off ratio at +8 dBm .

Maximum Pulse Repetition Frequency: >3 MHz

Minimum Pulse Duty Cycle: No restrictions on duty cycle.

Pulse Level Accuracy (relative to CW): ± 1.0 dB

Pulse Overshoot: <10 %

Input Impedance: 50 Ω nominal; TTL drive levels

Maximum Leveled Output Power in Pulse Mode (relative to CW): -0.5 dB

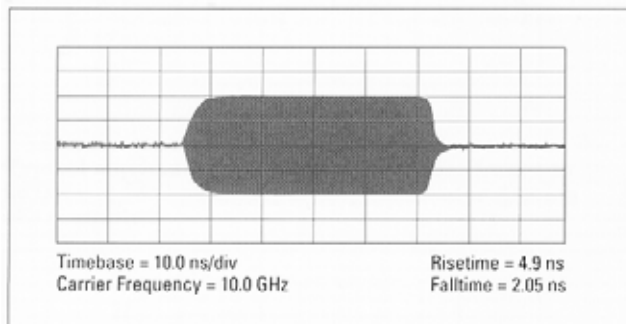

Typical pulse modulation envelope illustrates the fast rise and fall times, excellent flatness and pulse fidelity of the HP 70340A.

Internal Pulse Source (Option 1E2)

Pulse Source Modes: Free-run, triggered with delay, doublet and gated. Triggered with delay, doublet and gated require external trigger source.

Pulse Repetition Frequency: 3 Hz to >3 MHz

Pulse Repetition Interval (PRI): 300 ns to 419 ns

Pulse Width (T_w): 25 ns to 419 ns

Variable Pulse Delay (free-run mode, T_d):

± 419 ns from sync pulse to video modulation

Variable Pulse Delay (triggered with delay & doublet modes, T_d): 225 ns to 419 ns with ± 25 ns jitter

Pulse Width/Delay/PRI Resolution: 25 ns

Pulse Delay (Video to RF, T_m): Nominally, <20 ns, 1 to 20 GHz

All pulse modulation specifications and supplemental characteristics apply during use of internal pulse source.

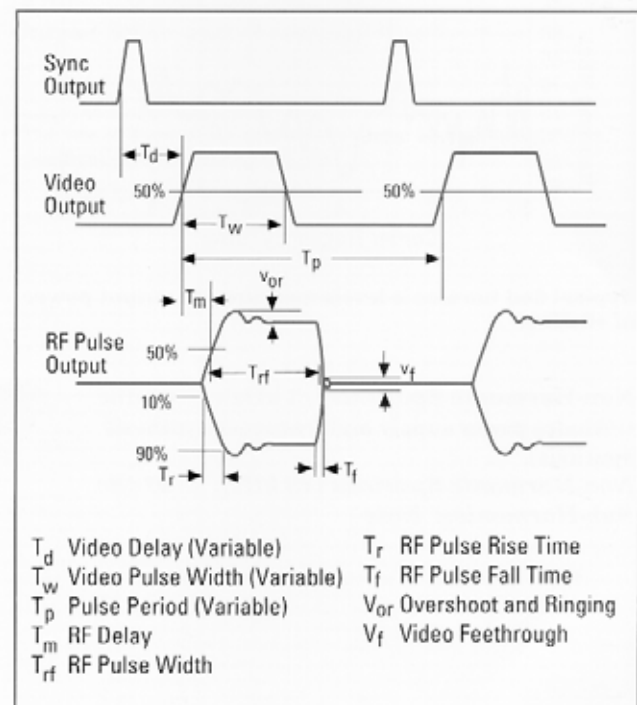

- T_d Video Delay (Variable)
- T_w Video Pulse Width (Variable)
- T_p Pulse Period (Variable)
- T_m RF Delay
- T_{rf} RF Pulse Width
- T_r RF Pulse Rise Time
- T_f RF Pulse Fall Time
- V_{or} Overshoot and Ringing
- V_f Video Feethrough

Frequency Modulation

Rates: 1 kHz to 1 MHz

Flatness: ± 2 dB

CARRIER FREQUENCY	256 - <500 MHz	500 MHz - <1 GHz	1 - <2 GHz	2 - 20 GHz	
Maximum Deviation	1.25 MHz peak	2.5 MHz peak	5 MHz peak	10 MHz peak	
	Maximum deviation decreases by a factor of 2 for each octave below 256 MHz				
Modulation Index	>37	>75	>150	>300	
	Modulation index decreases by a factor of 2 for each octave below 256 MHz.				
CARRIER FREQUENCY	10 - <16 MHz	16 - <64 MHz	64 - <256 MHz	256 MHz - <1 GHz	1 - 20 GHz
FM Sensitivity	40 kHz/V	80 kHz/V	320 kHz/V	1.25 kHz/V	5 MHz/V
FM Sensitivity Accuracy	$\pm 25\%$ at 100 kHz.				
Incidental AM	<5%				
FM Input Impedance	600 Ω nominal				
Harmonic Distortion	<1% (1 MHz peak deviation @ 100 kHz rate)				

Logarithmic Amplitude Modulation (Scan Modulation)

Maximum Depth: > 60 dB

Sensitivity: -10 dB/V; (0 to +6V for 0 to -60 dBc)

Step Response (50 dB change in level):

	<1 GHz	1 - 20 GHz
rise time	<10 μ s	<5 μ s
fall time	<20 μ s	<5 μ s

Input Impedance: 5000 Ω nominal

Maximum Leveled Output Power in Log AM Mode (relative to CW):

<1 GHz	1 - 4 GHz	>4 GHz
0 dB	-4.5 dB	-1.0 dB

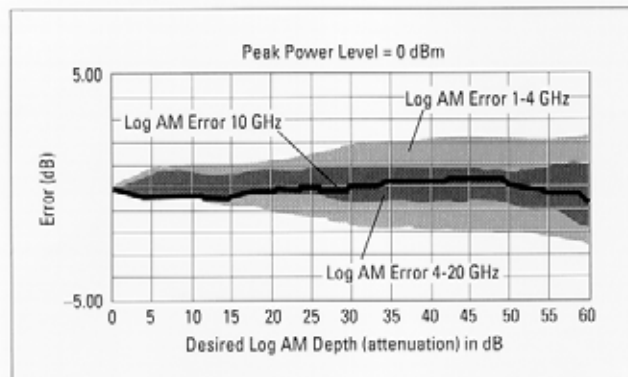

Typical log AM error (deviation from desired depth) at 25°C for carrier frequencies between 1.0 and 20 GHz.

Simultaneous Modulations

Full AM bandwidth and depth is available at any pulse rate or width. FM is completely independent of AM and pulse modulation.

General

Programming

The HP 70340A and HP 70341A are fully compatible with the Standard Commands for Programmable Instruments (SCPI). SCPI programming complies with IEEE 488.2-1987. Optional CIIL programming compatibility is available. Please consult your HP sales representative for details.

Environmental

Operating Temperature Range: 0° to 55°C

EMC: Meets or exceeds EN 55011/CISPR 11/1990, Class A and Mil-Std-461C Part 4 RE02, CE03, CS02, RS03.

Physical Dimensions

Net Weight: HP 70340A, < 9 kg (20 lb).

HP 70341A, <2.5 kg (5 lbs).

Shipping: HP 70340A, < 15 kg (30 lb).

HP 70341A, <6 lg (12 lbs).

Size: HP 70340A, 4/8 MMS module width.

148.5 mmH x 192.8 mmW x 477.5 mmD.

HP 70341A, 1/8 MMS module width.

148 mmH x 48.2 mmW x 477.5 mmD.

Power Consumption: HP 70340A, < 80 Watts.

HP 70341A, <30 Watts.

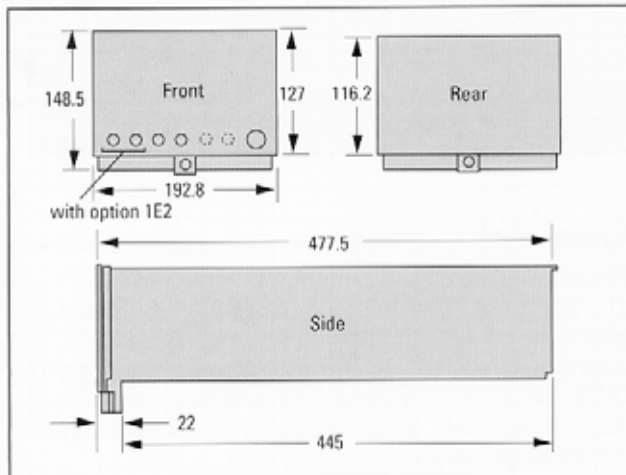

HP 70340A Dimensions in millimeters

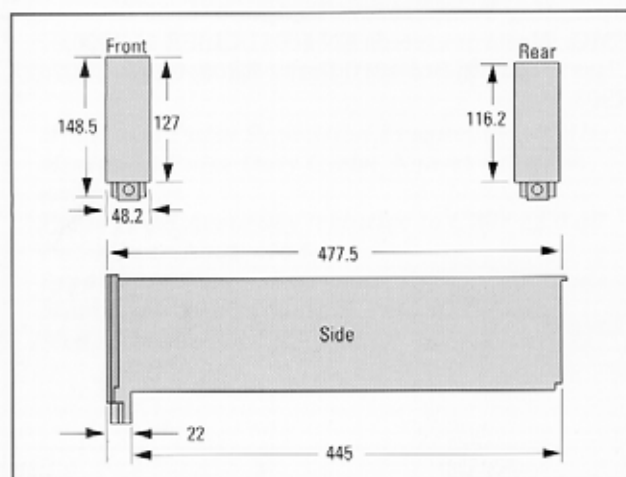

HP 70341A Dimensions in millimeters

Ordering Information

HP 70340A Modular Signal Generator

HP 70341A Frequency Extension Module

Option 1E1 Add Output Step Attenuator

Option 1E2 Internal Pulse Modulation Generator

Option 1E8 1 Hz Frequency Resolution

Option 1E9 3.5 mm RF Output Connector

Option 0B2 Extra Operating Manual

Option 0BV Service Documentation, Component Level

Option 0BW Service Documentation, Assembly Level

Option W30 2 Years Additional Return to HP Service

Option W32 3 Years Return to HP Calibration Service

Option W34 3 Year Mil-Std Calibration Service

Longer term warranty and calibration services are available, please consult your HP sales representative for details.

Rear Panel Connectors

0.5-1 GHz Output:

Outputs a 0.5 to 1.0 GHz signal for driving the HP 70341A Frequency Extension module.

0.01-1 GHz Input:

Accepts the HP 70341A 0.01-1 GHz output signal. The HP 70341A signal is output step attenuated in the HP 70340A with the 0.01 to 1.0 GHz output available at the front panel output connector of the HP 70340A.

10 MHz Input:

Accepts a 10 MHz \pm 100 Hz, 0 to +10 dBm, external reference signal for operation from an external high stability timebase. Nominal input impedance is 50 Ω .

10 MHz Output:

Outputs the 10 MHz external reference signal, nominally +3 dBm, for use as an external reference signal for other modules.

External ALC Output:

Outputs external ALC drive signal (from front panel EXT ALC input connector) to frequency extension modules.

ALC Control Output:

Supplies a -10 to +10 V signal as a reference for leveling the .01 to 1.0 GHz output signal of the HP 70341A.

0.5 V/ GHz Output:

Supplies a voltage proportional to output frequency for use with mm-wave frequency multipliers, including the HP 835XX Series.

AM Output:

Outputs AM modulation drive signal (from front panel EXT AM input connector) to frequency extension modules.

Pulse Output:

Outputs pulse modulation drive signals (from front panel EXT PULSE input connector) to frequency extension modules.

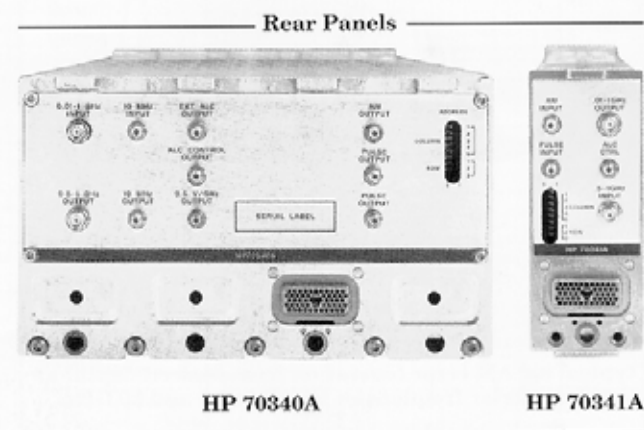

For more information, call your local HP sales office listed in your telephone directory. Ask for the Test and Measurement Department, or write to Hewlett-Packard.

Product specifications and descriptions in this document subject to change without notice.

© Agilent Technologies, Inc. 1992
Printed in USA, August 1, 1992
5091-4649E